

KAN Study 50

Operating forces on agricultural machinery

Analysis and measurement of manual operating forces;
resulting recommendations

Concluding report dated 30 July 2013



The "Commission for Occupational Health and Safety and Standardization" project is supported financially by the German Federal Ministry of Labour and Social Affairs (BMAS).

Authors: Dr.-Ing., M.Sc. André Klussmann
B.Sc. Patrick Serafin
Dipl.-Ing. Andreas Schäfer
Dipl.-Ing. Martin Keuchel
Bernd Neumann, network and system technician (TAW)
Dipl.-Ing. Karl-Heinz Lang

Institute of Occupational Medicine, Safety and Ergonomics
(ASER) at the University of Wuppertal

Published by: Association for the Promotion of Occupational Safety in
Europe (VFA)

Editorial control: Katharina von Rymon Lipinski
Commission for Occupational Health and Safety and
Standardization (KAN) – Secretariat
Alte Heerstrasse 111 – 53757 Sankt Augustin – Germany
Tel.: +49 2241 231-3467
Fax: +49 2241 231-3464
E-mail: info@kan.de
Internet: www.kan.de

ISBN 978-3-9816319-1-3

Contents

Summary	5
1. Introduction	7
1.1 Background to the study	7
1.2 Objectives of this study	8
1.3 Structure of the present report.....	9
2. Terms, definitions and background	10
2.1 Basic principles of ergonomics.....	10
2.2 Physical strength	10
2.3 Measurement techniques for the determining of forces	12
2.4 The benefits and drawbacks of different measurement techniques	15
2.5 Methods for determining the isometric maximum force.....	17
2.6 Requirements placed upon the measurement method to be developed.....	17
3. Operating forces on agricultural machinery	19
3.1 Operation of levers	19
3.2 Swivelling of flaps, covers, shrouds and components.....	20
3.3 Moving of steps and ladders.....	21
3.4 Other operations/movements.....	22
4. State of the art and scientific progress in the measurement of operating forces (on agricultural machinery)	24
4.1 Existing test methods for the measurement of operating forces	24
4.2 Values/force limits stated in standards concerning operating forces for mobile machinery used in agriculture.....	28
4.3 Comparison of the force limits in standards with isometric maximum operating forces determined empirically	30
4.4 Review and evaluation of existing reports	31
4.5 Consultation of manufacturers regarding measurement methods used to date	34
5. Trialling of measurement methods	35
5.1 Description of the measurement methods used	35
5.2 Trialling of operating scenarios in the field	44
5.3 Trialling of operating scenarios in the laboratory.....	45
6. Determining of guideline values for maximum forces	48
6.1 Methods and test collectives studied for the determining of maximum forces.....	48
6.2 Classification of the representativeness of the selected test subjects	49
6.3 Maximum forces for various operating scenarios.....	51
7. Summary of the results	54
7.1 Summary of the results from the measurements conducted in the field concerning the usability of the methods.....	54

7.2 Summary of the results from the laboratory measurements concerning the reproducibility of the methods 54

7.3 Summary of the guideline figures determined for maximum forces 58

8. Findings and recommendations 60

8.1 Findings 60

8.2 Recommendations 61

9. Literature 69

10. Annexes..... 72

Annex 1: Overview of the standards analysed..... 72

Annex 2: Passages concerning operating forces in standards 74

Annex 3: Trialling of operating scenarios in the field 80

Annex 4: Trialling of operating scenarios in the laboratory.....102

Annex 5: Results of force measurements.....112

Annex 6: Guideline values for maximum forces123

Summary

Introduction

Despite increasing automation, operating forces associated with the use of machinery still frequently constitute a sticking point that must be addressed during ergonomic design of the components concerned. High operating forces may be required on some machines for the manual operation of levers and the swivelling of flaps, covers, shrouds and ladders, particularly on mobile agricultural machinery. Guidance is available on the force limits that must be considered during the design and construction of mobile agricultural machinery in order for these tasks to be possible and tolerable; however, it frequently remains unclear how force measurements are actually to be performed in practice in order for the observance of these limits to be verified. In addition, the recommendations for force limits made to date are not sufficient. The work described in the present paper was performed in the course of a study commissioned by KAN, the Commission for Occupational Health and Safety and Standardization.

Method:

Typical operating scenarios on agricultural machinery were analysed in the field and in the laboratory. These essentially include the operation of levers and the swivelling, engaging and disengaging of flaps, covers, ladders and other components. Based upon studies of standards and the literature, two methods were developed for measurement of the forces required for operation of manually operated parts on agricultural machinery. The two methods were also evaluated with regard to the reproducibility of their results and their suitability for application in the field. The first measurement method was a comparatively simple method involving a hand-held force meter and generation of movement by a human operator. The second, more complex measurement method involved the use of a winch by which the movement was generated automatically.

In order to permit estimation of the maximum forces that can actually be exerted in various body postures, the forces concerned were measured in several directions of exertion in body postures typically encountered during the use of agricultural machinery, and evaluated statistically. The results were presented in such a way as to provide designers of agricultural machinery with basic guidance on the distribution of the maximum forces that must be exerted during the operation of manually operated parts in various body postures.

Results and discussion:

The complex method delivers greater reproducibility but is more resource-intensive. Provided certain boundary conditions are observed, the simple method is however also capable of delivering reproducible results relatively quickly and easily. The resulting guideline values for maximum forces serve as a basis for estimation of the performability. Broader validation of the data would be

desirable, as it would enable the methods to be trialled for extrapolation to other machine types.

Recommendations:

The study recommends and describes force measurement methods that can realistically be conducted in operating scenarios on agricultural machinery and that determine with adequate accuracy whether the operation is performable. Recommendations are also made regarding the positions of manually operated parts and the maximum force levels in the various postures. Guideline values are stated for this purpose.

For the performance of force measurements, recommendations are formulated regarding the aspects of the measurement equipment (measurement principle, measurement apparatus, resolution and accuracy of the apparatus), the arrangement, conditions and performance of testing (local conditions [e.g. in the laboratory, in the field], temperature, atmospheric humidity, test procedure, repeat testing, distance of operation/distance of measurement), definition of the operating force (application point and direction of the force), form and monitoring of the generation of movement (manual, gravity-induced or automated), selection and preparation of the item under test (selection, preparation/treatment), form of presentation of the results (determining of the final result, consideration of the peak value [discrete measurement], dynamograph [force/distance characteristic or force/time characteristic]) and the structuring of the content of the measurement log and test report.

In order for operating scenarios on agricultural machinery to be defined in the standards and optimized, recommendations are presented for the designers of agricultural machinery, for the Ergonomics standards committee, for the Agricultural Machinery standards committee and the VDMA (Verband Deutscher Maschinen- und Anlagenbau e.V.), and for the German Federal Ministries of Education and Research (BMBF) and of Labour and Social Affairs (BMAS).

Note: The term "manually operated part" is used in this document in reference to any machine part that is moved manually by the operator, such as levers, flaps, covers, shrouds and ladders.

1. Introduction

1.1 Background to the study

In order to avoid or minimize injury and harm to the health of operators of the machinery (commercial users at the workplace, consumers in the domestic sphere) during the use of machinery as intended, the essential health and safety requirements of the 2006/42/EC Machinery Directive must be satisfied by the design and construction of machinery. This includes observance of the ergonomic principles. In accordance with the principle of ergonomics (2006/42/EC Machinery Directive, Annex I, No 1.1.6), the discomfort, fatigue and physical and psychological stress faced by the operator must be reduced to the minimum possible, taking into account ergonomic principles such as allowing for the variability of the operator's physical dimensions, strength and stamina, or by providing sufficient space for movements of the parts of the operator's body.

The basis for the present KAN Report was a previous study, also launched by the Commission for Occupational Health and Safety and Standardization, into the "Safety of agricultural machinery" (KAN Report 41) [1]. The recommendations made in KAN Report 41 triggered a process of standards review at national level, in the course of which the topic of operating forces was also discussed. For example, a number of standards frequently refer to EN 1005 Part 3, Recommended force limits for machinery operation [2] in relation to the dimensioning of operating forces. This standard does not however describe a measurement method; rather, it formulates an analysis method by which maximum permissible physical forces can be determined from measured maximum force distributions. For this purpose, recommendations are issued concerning the percentiles to be considered in various cases, in conjunction with multiplicative adjustment parameters (for example for the frequency of movement, duration, etc.). Selected maximum force values are also presented. The values shown always relate to ideal ergonomic working conditions. Important influencing factors, such as the direction of force and the point of force application, are considered only marginally, if at all. Since flaps, controls and other manually operated parts on agricultural machinery must often be moved under highly unergonomic conditions, these values cannot be employed for standards governing agricultural machinery. In addition, no scientific validation of the values is provided, nor is combination of the adjustment parameters described.

It may be assumed that no standard for the measurement of operating forces exists at present either in Germany or internationally to which reference could be made for the measurement of operating forces on parts of mobile machinery such as agricultural machinery.

Operating forces are of great importance specifically in the case of agricultural machinery. A whole range of working procedures require the operating personnel to exert operating forces at a level above the average for other tasks performed

in agriculture. Dimensioning these forces such that various persons working in agriculture are still able to use the machinery – even when consideration is given to the increasing stiffness of manually operated parts resulting from longer periods in service and soiling and which cannot generally be avoided entirely – is one of the challenges facing the designers of mobile agricultural machinery.

Besides the differences in body dimensions of the operating personnel, the differences in their physical strengths are crucial for the ergonomic design of the parts of mobile agricultural machinery that are to be moved by hand. The available information on human action forces takes the form of distributions of human physical strengths, generally measured as maximum forces. These action forces may however vary widely depending upon the direction of force and point of force application. Body posture and the sex and age of the individuals may be significant influencing factors. The atlas of forces for specific assembly tasks [3] for example contains distributions for specific assembly tasks that illustrate this variation very clearly.

Examination of these operating scenarios on machinery also requires suitable methods by means of which the corresponding operating forces can be measured. The measurement of forces is however found to be an area that is particularly poorly described in standards. This can be seen clearly from KAN Report 46, "Measurement requirements in product standards" [4]. An analysis of a total of 941 standards and draft standards for provisions relating to physical measured variables and where applicable the necessary measurement methods yielded 775 measurement provisions for the measurement variable of "force"; the force measurement was consistently regarded as "not trivial", yet for only 45% of the stated values was reference made to a measurement method. In the area of agricultural machinery, operating forces are substantially more difficult to describe owing to the influencing variables already referred to, such as the direction of force, point of force application, progression of movement, etc. The methods stated in KAN Report 46 are therefore of only limited suitability for measurement of the operating forces on agricultural machinery (see also Chapter 4).

The design and construction of machinery thus presents two challenges. Firstly, meaningful distributions of the human action forces are required for various force scenarios in consideration of the operating personnel (both men and women, and of various ages); secondly, a measurement method is needed by means of which the forces required for the operation of machinery can be measured reproducibly.

1.2 Objectives of this study

The background to this study as described above gives rise to the following three discrete objectives.

- 1) The first discrete objective of the study is to describe the state of the art and current scientific progress in this area.

- 2) The second discrete objective of the study is to identify and describe, based upon the first discrete objective, one or more measurement methods, and to trial these methods in practice and adapt them as necessary.
- 3) The third discrete objective of the study is to compile guideline values for maximum forces that can assist the designer of a mobile agricultural machine in ensuring that the various users in agriculture (men, women, young persons and older workers) are able to operate it ergonomically.

1.3 Structure of the present report

The structure of the present report follows the sequence of discrete objectives described above.

For attainment of the first discrete objective, terms and definitions will first be explained and methods for the measurement of forces presented and discussed in Chapter 2. With consideration for typical operating scenarios in agriculture (Chapter 3), the state of the art and current scientific progress in the area will be described in Chapter 4. For this purpose, standards are surveyed in order to identify operating forces on machinery (Section 4.1) and the values and force limits described in agricultural standards (Section 4.2), and the results compared with maximum forces determined by empirical means (Section 4.3). This is followed by discussion of a pilot report on the issue, which was commissioned by KAN ahead of the present study (Section 4.4). Consideration is also given to how manufacturers of agricultural machinery have addressed this issue up to now (Section 4.5).

For attainment of the second discrete objective, Chapter 5 first presents two different measurement instruments and methods (Section 5.1); it then trials them in various operating scenarios in the field (Section 5.2) and in the laboratory (Section 5.3), in order to evaluate their suitability for use in the field and the accuracy of the resulting measurements of operating forces on mobile (agricultural) machines.

For attainment of the third discrete objective, Chapter 6 presents guideline values for maximum forces which may be of assistance to designers of mobile (agricultural) machinery in order to assure ergonomic operation of the mobile (agricultural) machinery by the various users in agriculture.

The results of this study are summarized in Chapter 7. Finally, recommendations based upon the results are summarized in Chapter 8.

2. Terms, definitions and background

This chapter states terms, definitions and issues discussed and described in the literature. Some sections are followed by boxes detailing how these are handled in the present report.

2.1 Basic principles of ergonomics

Whether a task is designed humanely can be described by the four levels of "performability", "tolerability", "acceptability" and "satisfaction" [5, 6, 7]. These four levels constitute a hierarchy. Accordingly, whether the operation could be performed at all by the operating personnel on the machine or part of the machine was first to be established. Consideration must be given here for example to whether body dimensions have been considered such that manually operated parts can be reached without the use of aids, and whether the body forces that can be exerted are greater than the maximum force required on the manually operated part. The second level considers the tolerability in the sense of freedom from harm. At this stage, consideration must also be given to whether the operation is possible on a daily basis over an entire working life without risk to the health of the operating personnel. The acceptability and satisfaction, the third and fourth levels respectively, are criteria over and above the minimum ergonomic requirements; they cannot be evaluated adequately by conventional ergonomic tools, and must be considered by means of methods from the social sciences, psychology or sociology.

To answer the problem posed by this report, only the "performability" of operations on machines and machine parts will be addressed. The authors consider this sufficient given the assumption that the manually operated parts considered here are operated only once or a few times per day, and also only seasonally. Evaluation of the tolerability of these operations on machines and machine parts would require long-term studies to be conducted. In view of the resources required for this purpose, this would be worthwhile only where comparable operating scenarios occur frequently and for longer durations.

2.2 Physical strength

One of the chief areas of ergonomics concerns human physical strength. Many standards governing the human-machine interface must state not only anthropometric data, but also physical strengths, particularly in order for the products designed in accordance with these standards to be made safe and healthy. As a function of the form of force application and force exertion and the form taken by the force, concepts such as the static action force, operating force, dynamic action force and holding force are also used in association with physical forces [8]. For the measurement of physical strengths and for interpretation of

the results obtained by various authors on the subject, harmonized definitions of terms and defined and closely monitored test conditions are absolutely essential. Only then can it be ensured that the results are interpreted correctly and determined whether the results from different surveys are comparable. As early as 1977, KROEMER [9] summarized the following inadequacies in publications on the topic of human physical strengths:

- Terminology that is unclear, ambiguous or misleading
- Inadequate consideration for physiological and/or biomechanical and/or psychological aspects
- Inadequate measurement equipment and measurement methods
- Incomplete or incomprehensible descriptions of performance of testing and of the statistical analysis of the results

Differences in the definition of terms and in the consideration given to various influencing variables lead to different measurement procedures and methods, as a result of which the quality of superficially comparable studies may vary. Further important factors relevant to the comparability of surveys of human physical strengths are for example the collective studied (for example the composition in terms of age and sex) and the ambient conditions prevailing during measurement [3, 9, 13, 18, 20].

DIN 33411 Part 1 [8] defines physical forces as forces associated with the human body. They may be defined with reference to the following parameters:

- Value of the force (F) in Newtons (N)
- Location of the force application point relative to the body
- Direction/axis of force application (relative to the body)
- Direction of force

Physical forces can be subdivided broadly into muscle, mass and action forces. Similar statements can also be made for physical torques; in this case, the effective lever arm must also be considered. Torques are stated in Newton metres (Nm) [8, 13]. The interaction of muscle, mass and action force is described in Fig. 1. Note in this context that action forces are the result of mass forces and generated muscle forces, but that human biomechanics are the factor determining the conversion of muscle force into an action force.

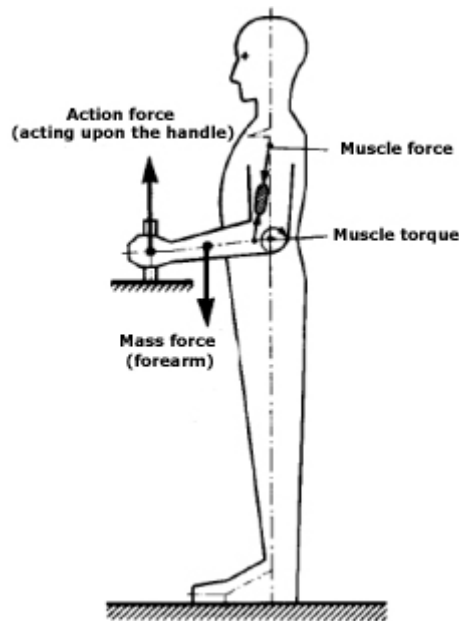

Fig. 1: Example of the interaction of action force with muscle and mass forces (taken from DIN 33411 Part 1 [8])

The action forces generated by the isometric voluntary maximum contraction of certain muscles or muscle groups that can be maintained in a specific force exertion scenario for a brief duration of two to six seconds are described as the isometric maximum force (personal maximum action force) [9, 10, 13, 14, 15]. The isometric maximum force can be determined very easily by experimentation, whereas determining the dynamic maximum force generally entails considerably greater resources. Not least for this reason, most available data on the subject of human physical forces take the form of isometric maximum forces [15]. These forces are measured with the aid of dynamometers in the form of action forces exerted outwardly. The action forces comprise the interaction between the mass force of the parts of the body involved, the forces generated by contraction of the muscle(s) involved, and human biomechanics. The capacity to perform work by a maximum dynamic voluntary muscle contraction is the dynamic maximum force [9-11, 13]. Measurement of maximum dynamic voluntary muscle contractions is however considerably more difficult and diverse, and is therefore seldom performed in practice.

Within the study upon which the present report is based, the maximum force measurements performed were those of isometric maximum forces (Chapter 6).

2.3 Measurement techniques for the determining of forces

2.3.1 Mechanical force meters

Mechanical force meters/pressure gauges are single-dimension instruments and are generally based upon the principle of elastic material deformation caused by the application of force, for example by the change in length of a coiled spring

(spring gauge) in accordance with Hook's law (spring force = spring constant \times difference in distance following application of the force) – refer for example to Fig. 2, or by the elastic change in geometry of a Bourdon tube or diaphragm (manometer/barometer) – refer for example to Fig. 3.

The benefits of purely mechanical instruments are, besides their generally low cost (below €100), their ease and flexibility of use. Their drawback is however that the value must be read off directly during measurement, or – where the instrument possesses a trailing pointer – only the maximum value can be determined following the measurement, which may possibly represent the value of a force that was exerted for only a few hundredths of a second.



Fig. 2: Example of a mechanical force meter: spring gauge



Fig. 3: Example of a mechanical force meter: Jamar dynamometer (manometer principle)

2.3.2 Hand-held electronic force meters

A range of hand-held electronic force meters are available (see for example Fig. 4 and Fig. 5) which calculate the exerted force, usually by changes in the electrical resistance generated by strain gauge strips or by changes in the distribution of a charge in piezoelectric sensors. Devices of this type are also generally one-dimensional instruments. Depending upon the type, force/time characteristics may be registered, displayed and logged in addition to the maximum force. The great majority of these force meters also offer interfaces and software enabling data to be downloaded from them to computers for further processing. Hand-held electronic force meters are generally in the middle price range (€500-€1,500), and can typically measure forces of up to 500 N.



Fig. 4: Example of a hand-held electronic force meter: Sauter FH 10.
Saving of force/time characteristics is not possible



Fig. 5: Example of a hand-held electronic force meter: PCE-FG 500.
Saving of force/time characteristics is possible

2.3.3 Complex computer-based force measurement systems

2.3.3.1 (Force) measurement systems with individual modulation

Complex measurements may require the use of more comprehensive measurement systems. A range of software products are available for the recording and analysis of measured data. They can be combined with any suitable sensors (such as force sensors, gradient sensors, etc.) in order to determine, visualize and record force progressions in one or more dimensions (see for example Fig. 6, Fig. 7).

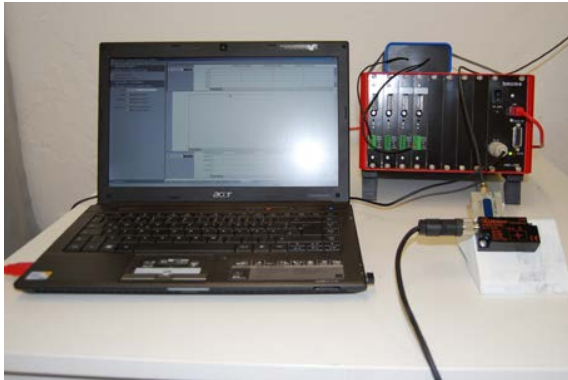

Fig. 6: Force measurement system based upon NextView software with measurement amplifier (bmcm), strain/pressure sensor (ME-Systeme) and gradient sensor (Kübler)



Fig. 7: The force measurement system shown in Fig. 6 fitted on the measurement apparatus, with additional automatic speed control provided by a winch

2.3.3.2 Dedicated force measurement systems

A small number of dedicated force measurement products are available on the market. These include the 3D hand force measurement system (Fig. 8), which is

able to record the exerted force in three components (axes/directions) simultaneously, and a measurement system employing a sensor mat, which can be used for example for force measurement on the palm of the hand (Fig. 9). These products enable very precise stress analyses to be produced. With purchase prices of around €40,000 for the 3D hand force measurement system and €30,000 for the sensor mats, they are however intended more for scientific studies, and are of only limited suitability for wider use in the field.

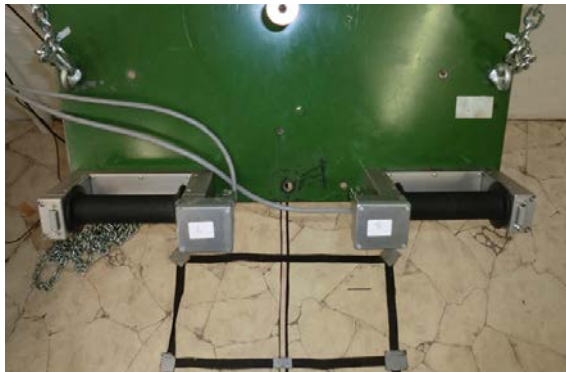

Fig. 8: 3D hand force measurement system (IFA/Kistler)



Fig. 9: Sensor mats (IFA/Novel)

2.4 The benefits and drawbacks of different measurement techniques

Two aspects must be considered for the analysis of forces:

- 1) Measurement of the actual actuating force in a specific case
- 2) Interpretation of this force value in terms of its relevance to humane design, for example with regard to the four levels referred to above of performability, tolerability, acceptability and satisfaction.

Ideally, three-dimensional dynamic force measurements should be performed under real-life conditions for 1) "measurement of the actual actuating force in a specific case". Conversely, the values obtained by 2) "the interpretation of this force value in terms of its relevance" would be compared to a database of maximum dynamic force characteristics measured in a representative manner.

2.4.1 Dynamic vs. isometric maximum force

As already described in Section 2.2, the measurement of maximum dynamic voluntary muscle contractions is significantly more difficult and diverse than the measurement of isometric maximum forces. A database of maximum dynamic force characteristics determined in a representative manner would be desirable, but its creation would be highly resource-intensive.

For this reason, the isometric maximum force is often determined, as in the present study. The drawback is that these values can be extrapolated to dynamic force characteristics only to a limited degree.

2.4.2 One-dimensional vs. three-dimensional force measurement

As described above, there are advantages to three-dimensional force measurements. Forces are known to constitute a vectorial value that can be described by its quantity, i.e. its magnitude/strength, and its direction, line of action or point of application. Three-dimensional force measurements enable the point of force application, force components and directions of force to be quantified.

For 1) however, "measurement of the actual operating force in a specific case", three-dimensional force measurements often cannot be performed under real-case conditions without limitations. 3D hand force measurement handles present the problem that they must be fitted to the component on which measurement is to be performed. The dimensions and geometry of the handles may lead to deviations from real-case force directions; this can however often be corrected retrospectively by recalculation. The higher resource requirements and high purchase price are however issues. These systems cannot therefore be regarded as practicable solutions for example for smaller manufacturers of agricultural machinery or for market surveillance authorities (refer in this context also to Section 2.6).

By contrast, the 3D hand force measurement handles are very well suited to creation of a database of isometric maximum forces for the purpose of 2), "the interpretation of this force value in terms of its relevance".

One-dimensional force measurements have the drawback that, as their name suggests, they record the direction of force in only one dimension, and thus only a subset of the force that must actually be exerted. Only a very limited estimation of internal stresses is therefore possible.

Since however the present study is concerned with operating scenarios that are performed only once or a few times a day and also strongly seasonally, it is considered sufficient to determine only the performability of the operating scenarios. For this purpose, the operating force is defined as the force perpendicular to the longitudinal axis of the manually operated part in the direction of movement that is required in order to complete the operating movement concerned in full. In other words, an ideal point of force application is assumed. This now enables 1) "measurements of the actual operating force in a specific case" to be performed by one-dimensional static force measurements under real-life measurement conditions (measurement of the force perpendicular to the longitudinal axis of the manually operated part in the direction of movement) and 2) "interpretation of this force value in terms of its relevance" to be compared with reference to a force database (of force values perpendicular to the longitudinal axis of the manually operated part in the direction of movement), and the performability to be estimated.

The limitation of this method is that these force values can be used only with limitations, if at all, for estimation of internal stresses, and therefore permit only

limited conclusions, if any, concerning the tolerability and the stresses upon the musculoskeletal system (refer in this context also to Section 2.1).

2.5 Methods for determining the isometric maximum force

Dynamometry (measurement of the external forces) is the measurement method most frequently used for determining the isometric maximum force in an operating scenario [9, 10, 13]. The literature is however not consistent on the question of the build-up of the force and the duration for which an isometric maximum force must be maintained during measurements. This has resulted in three different methods being used in the past for dynamometric measurement of the isometric maximum force: the "square method", the "ramp method" and the "jerk method" [9, 13, 18, 20]. In the "square method", the maximum force is built up continuously within one second and is then held constant. In the "ramp method", the force is built up continually until the maximum force is reached. The "jerk method" requires the force to be built up as quickly as possible by a series of pulses (Fig. 10).

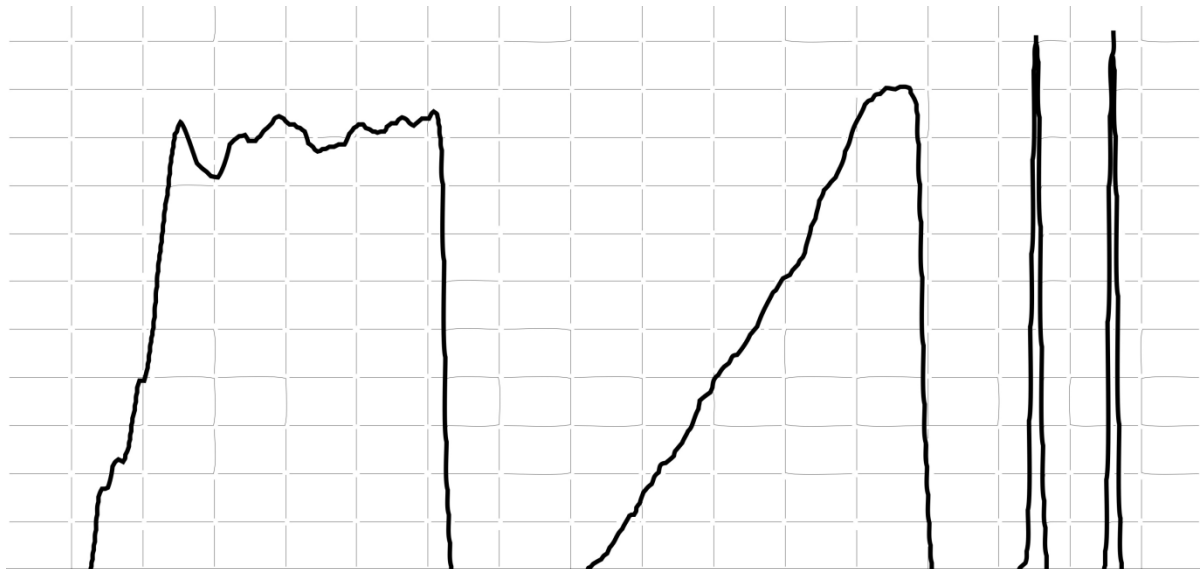

Fig. 10: Square method (left), ramp method (centre), jerk method (right)

The method predominantly used at present is the "square method". Unfortunately, authors frequently fail or have failed to indicate in the literature which of the above methods was used. Caution is therefore particularly advised in comparing force values taken from different literature sources, since the ramp method generally yields substantially higher values [21].

2.6 Requirements placed upon the measurement method to be developed

The invitation to tender for the present study and the meetings of the working group supervising the project held during its course defined requirements to be placed upon the measurement method that was to be developed.

These included consideration for the following points:

- The measurement method was to be highly reproducible.
- Measurement was to be non-destructive and was not to damage paintwork.
- The measures required for performance of measurement were to be as simple as possible.

In particular, this meant that small and medium-sized machinery manufacturers were also to be enabled to perform these measurements. Labour inspectors of the market surveillance authorities and German Social Accident Insurance Institutions were to be able to perform these measurements at visits to manufacturers' premises, in order for example to verify the values stated in standards or other values stated by the manufacturer.

In order for measurement methods to be trialled (see Chapter 5), both a hand-held electronic force meter and a computer-based force measurement system were used. Both systems employed one-dimensional force measurement. Given the requirement for measurements to be performed by the simplest means possible and at the same time only for the "performability" to be considered, this was regarded as adequate. For this purpose, the operating force is defined as the force perpendicular to the longitudinal axis of the manually operated part in the direction of movement that is required in order to complete the operating movement concerned in full. In other words, an ideal point of force application is assumed. In addition, measurements were performed in selected cases in laboratory studies by means of a 3D hand force measurement system.

In order for guideline values for maximum forces to be determined (see Chapter 6), isometric maximum forces were defined by means of the square method. Test subjects were required in this case to increase the force to the maximum within 1 second and then to hold it for 3 seconds. The isometric maximum force was defined as the mean value in a 2-second interval around the absolute maximum value within this 3-second period. If within these 2 seconds the deviation from the absolute maximum value was greater than 20%, the measurement was rejected. In order for these guideline values to be comparable to the measured operating forces, the force was measured perpendicular to the longitudinal axis of the manually operated part in the direction of movement.

The benefits of the method described here are that both determining of the operating force and comparison of the values with the guideline values are relatively quick and straightforward.

The limitation of this method is that these force values can be used only with limitations, if at all, for estimation of internal stresses, and therefore permit only limited conclusions, if any, concerning the tolerability and the stresses upon the musculoskeletal system. Given that the operating scenarios are performed only once or a few times a day and also only seasonally, this is considered sufficient for the purpose under consideration.

3. Operating forces on agricultural machinery

This chapter describes typical operating scenarios on agricultural machinery.

3.1 Operation of levers

Manually operated levers are very often found on agricultural machines. Selected typical operating scenarios are shown in Fig. 11 to Fig. 16.



Fig. 11: Opening of a grain tank on a combine harvester (Claas Avero); a full turn is required to open the tank



Fig. 12: Opening of a grain tank on a combine harvester (Claas Mega 350); half a turn is required to open the tank



Fig. 13: Slide gate on a trailer (Hilken)



Fig. 14: Chopper adjustment on a combine harvester (John Deere T560)



Fig. 15: Chopper adjustment on a combine harvester (Claas Mega 350)



Fig. 16: Chopper adjustment on a combine harvester (John Deere T560)

3.2 Swivelling of flaps, covers, shrouds and components

Manually operated flaps, covers, shrouds and components are also frequently found on agricultural machines. Choppers on combine harvesters are an example. Selected typical operating scenarios are shown in Fig. 17 to Fig. 26.



Fig. 17: Side flap on a chopper-type forage harvester (John Deere)



Fig. 18: Side flap on a combine harvester (Claas Mega 350)



Fig. 19: Cover on a seed drill (Sulky Tramline SE)



Fig. 20: Cover on a seeder (Sfoglia K4 sf)



Fig. 21: Side flap on a big baler (Kuhn LSB 1270)



Fig. 22: Side flap on a big baler (John Deere 1424)



Fig. 23: Side flap on a big baler (Krone)



Fig. 24: Side flap on a round baler (Claas Rollant 455)



Fig. 25: Manual chopper adjustment on a combine harvester (Claas Mega 350).
This form of manual chopper adjustment is frequently found on smaller combine harvesters



Fig. 26: Manual chopper adjustment on a combine harvester (Claas Mega 350)
The chopper is raised with one hand and engaged in position with the other

It is notable that highly unergonomic body postures must be assumed in some cases, particularly in the operating scenarios described here of "operation of levers" and "swivelling of flaps, covers, shrouds and components". Some flaps may barely be within reach. Owing to their high weight, the flaps and twine stock on big balers and the choppers on combine harvesters may require high forces in the operating scenarios discussed here.

3.3 Moving of steps and ladders

Fig. 27 to Fig. 30 show certain typical steps and ladders on agricultural machinery.



Fig. 27: Swivel ladder on a combine harvester (Claas Mega 350)



Fig. 28: Ladder to the grain tank on a combine harvester (Claas Mega 350), with engaging arrangement



Fig. 29: Fold-up steps on a combine harvester (Claas)



Fig. 30: Swivel steps on a combine harvester (New Holland CX 5090)

3.4 Other operations/movements

Fig. 31 and Fig. 36 show further selected operating scenarios on agricultural machines.



Fig. 31: Star-grip knob for chopper adjustment on a combine harvester (Claas Mega 350)



Fig. 32: Star-grip knob for chopper adjustment on a combine harvester (Claas Avero)



Fig. 33: Coupling on a slurry truck



Fig. 34: Swivel-release mechanism on the steps of a combine harvester (Claas Mega 350)



Fig. 35: Angle adjustment with locking screw on a manure spreader (Rabe Adler DSX 36)



Fig. 36: Angle adjustment with locking screw

4. State of the art and scientific progress in the measurement of operating forces (on agricultural machinery)

This chapter describes the state of the art and of scientific progress for the measurement of operating forces on agricultural and similar machinery, summarizes the results of three reports on the subject commissioned by KAN, and further considers how manufacturers of agricultural machinery have addressed this topic to date.

4.1 Existing test methods for the measurement of operating forces

4.1.1 Standards governing the measurement of operating forces on agricultural machinery

A comprehensive survey of standards was performed by means of the NoRA standards search tool and suitable keywords. The search revealed no standards specific to the measurement of operating forces on agricultural machinery.

4.1.2 Standards governing the measurement of operating forces in other product areas

In response to a proposal by KAN, two standards were first considered that had been regarded as potentially useful prior to performance of the present study. These are "NPR 2739, Menselijke fysieke belasting – Kenmerken en meetmethoden" (Dutch standard governing human physical stress, characteristic values and measurement methods) [23] and "NF X 35-109, Manutention manuelle de charge pour soulever, déplacer et pousser/tirer – méthodologie d'analyse et valeurs seuils" (French standard governing ergonomics, manual handling of loads for lifting, moving, and pushing/pulling, analysis methods and threshold values) [24].

The focus of NPR 2739 [23] lies upon measurement and recording of the human physical constitution, stress, and body movements and postures. Load parameters and aspects of the working environment are considered. Overall, this standard is limited to describing the general options for measurement, suitable measurement equipment, and definitions of terminology. It contains no provisions concerning measurement arrangements or for the specific performance of measurements of operating, actuating or adjustment forces.

NF X 35-109 [24] focusses upon the evaluation of load handling operations, states load limit values, and is in principle comparable with the key indicator methods [25, 26] and with ISO 11228 Parts 1-2 [27, 28]. It likewise contains no provisions concerning measurement arrangements or the specific performance of measurements of operating, actuating or adjustment forces.

Based upon KAN Report 46 [4] and searches in NoRA, standards and codes were however identified describing arrangements for force measurement (see Table 1). In summary, the following aspects are considered:

1. Measurement apparatus (principle of measurement, e.g. weights or measurement, measurement equipment, resolution and trueness of the measurement equipment)
2. Test arrangement, conditions and performance of testing (local conditions [e.g. laboratory, field], temperature, atmospheric humidity, setup, procedure and performance of repeat tests, operating/measurement distance)
3. Definition of the operating force (point of force application and direction of force)
4. Form and monitoring of the generation of movement (manual, gravity-induced or automated)
5. Selection and preparation of the item under test (selection, preparation/treatment)
6. Form of presentation of the results (determining of the final result, consideration of the peak value [discrete measurement], dynamograph [force/distance or force/time characteristic])
7. Measurement log and test report

The distinction between maximum and average forces during the exertion of force is addressed for example by DIN prEN 13561, External blinds and awnings – Performance requirements including safety. This standard specifies that the operating force F_c is defined by two values. F_{CP} is the maximum peak force required for disengagement of the arms during the first turn of the awning shaft in the direction of retraction when the jointed-arm awning is fully extended; F_{CN} is the maximum operating force required during the remaining movement (retraction or extension process) (see Fig. 37).

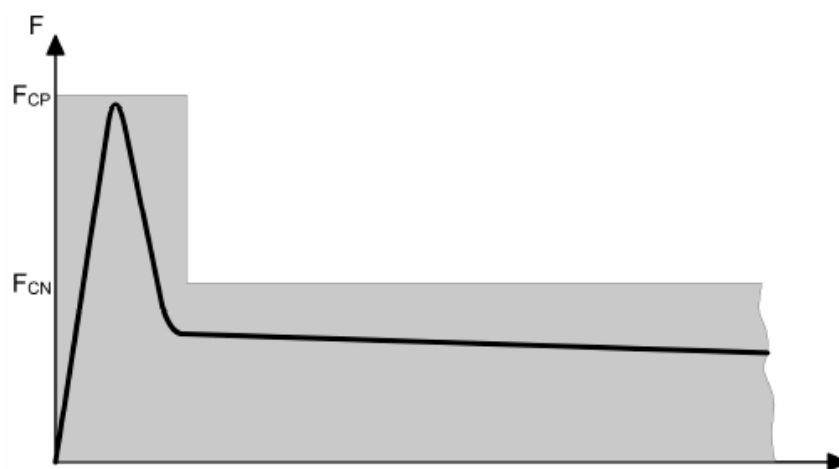

Fig. 37: Separate treatment of maximum forces and average forces. Example from DIN prEN 13561, External blinds and awnings – Performance requirements including safety

For torques for example, EN 12046-1, "Operating forces – Test method – Part 1: Windows" uses pulleys to determine the operating force (see Fig. 38 and Fig. 39).

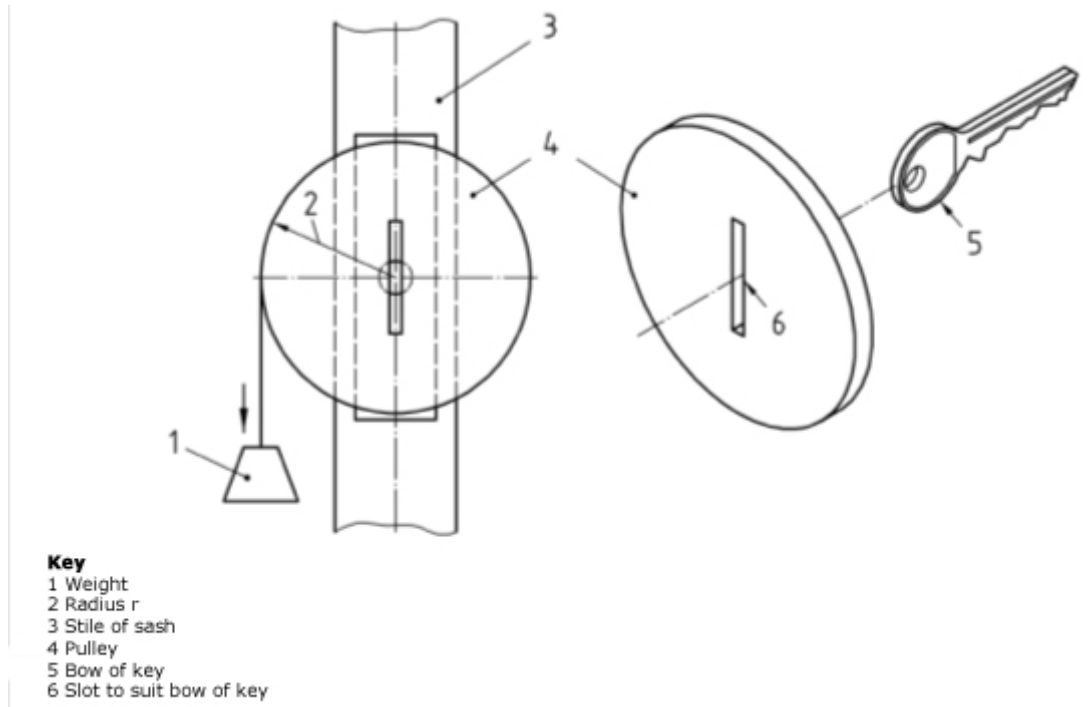

Fig. 38: Mechanism with weight and pulley shown used on a key (from EN 12046-1)

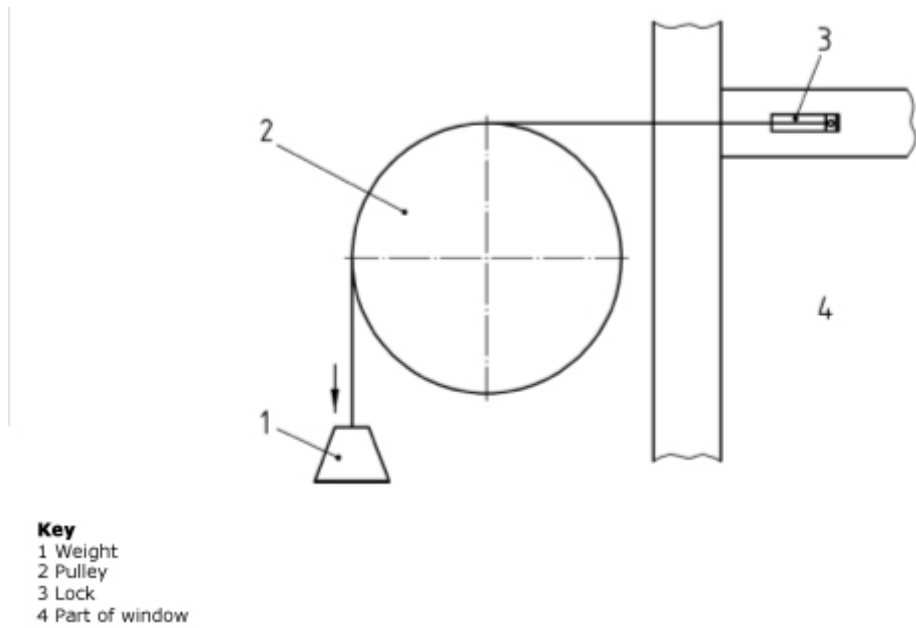

Fig. 39: Mechanism with weight and pulley shown used on a lock (from EN 12046-1)

Table 1: Standards containing provisions on measurement assemblies and/or on the specific performance of measurements of operating forces

Document	Title of the standard	Provisions concerning*
EN 125:2010	Flame supervision devices for gas burning appliances – Thermoelectric flame supervision devices	1, 2, 3, 6
EN 709:2011	Agricultural and forestry machinery – Pedestrian controlled tractors with mounted rotary cultivators, motor hoes, motor hoes with drive wheel(s) – Safety	1, 2, 3, 5, 6
EN 816:1997	Sanitary tapware – Automatic shut-off valves	1, 2, 5
EN 1106:2010	Manually operated taps for gas burning appliances	1, 2, 3, 6
EN 1493:2010	Vehicle lifts	2, 3, 6
EN ISO 3691-5:2009**	Industrial trucks – Safety requirements and verification – Part 5: Pedestrian-propelled trucks	1, 2, 3, 5, 6
EN 3841-502:2004	Aerospace series – Circuit breakers – Test methods – Part 502: Operating forces	2, 3, 6
prEN ISO 1168 1-1:2009	Machinery for forestry – Portable chain-saw safety requirements and testing – Part 1: Chain-saws for forest service	2, 6
EN 12046-1:2003	Operating forces – Test method – Part 1: Windows	1, 2, 3, 4, 5, 6, 7
EN 12046-2:2000	Operating forces – Test method – Part 2: Doors	1, 2, 4, 5, 6, 7
prEN 12183:2011	Manual wheelchairs – Requirements and test methods	1, 2, 3, 5, 6, 7
EN 12541:2002	Sanitary tapware – Pressure flushing valves and automatic closing urinal valves PN 10	1, 2
prEN 12605:2005	Industrial, commercial and garage doors and gates – Mechanical aspects – Test methods	2, 5, 6, 7
EN 13527:1999	Shutters and blinds – Measurement of operating force – Test methods	1, 2, 3, 5, 6, 7
prEN 13561:2011	External blinds and awnings – Performance requirements including safety	6
DIN 18267:2005	Window handles – Clickable and lockable window handles	2, 3, 5, 6, 7
DIN 45679:2005	Mechanical vibration – Measurement and evaluation of coupling forces for assessment of vibration exposure of the hand-arm system	1, 2, 3, 4, 6, 7
EN 60512-13-1&2:2006	Connectors for electronic equipment – Tests and measurements – Part 13-1: Mechanical operation tests – Test 13a: Engaging and separating forces & Part 13-2: Mechanical operation tests – Test 13b: Insertion and withdrawal forces	2, 5, 6, 7
* 1. Measurement apparatus; 2. Test arrangement, conditions and performance of testing; 3. Definition of the operating force; 4. Nature of the generation of movement; 5. Selection and preparation of the item under test; 6. Form of presentation of the results; 7. Measurement log and test report		
** Formulations similar to those stated here can be found in further standards governing industrial trucks, such as EN 1570:1998 +A2:2009; EN 1494:2000 + A1:2008; EN 1757-1:2001; EN 1757-2:2001 and EN 1757-3:2002		

Further standards and codes were also identified containing information on the specification of operating forces and on the adjustment and calibration of instruments (see Table 2).

Table 2: Selected standards containing information on the specification and measurement of operating forces

Document	Title of the standard
EN 12570:2000:	Industrial valves Method for sizing the operating element
VDI/VDE 2624 Blatt 2.1	Measurement of mechanical quantities – Instructions for calibration of mobile force measurement systems
VDI/VDE 2624 Blatt 4.1	Measurement of mechanical quantities – Non-rotating static calibration of the measure torque on performance test stations

The measurement methods for operating forces studied here contain gaps, particularly in their descriptions of the generation of movement, the speed of movement and monitoring of the measurement movement, and in specification and control of the direction of force. Methods for automated measurement of operating forces or solutions for the monitoring of the measurement movement and the direction of force are not described in the standards studied. The provisions governing the instruments used are also frequently deficient.

In the area of agricultural machinery, the methods described above cannot be adopted verbatim, owing firstly to the multitude of different operating forces and secondly to the multitude of influencing variables such as the direction of force, point of force application, progression of movement, etc. The provisions are frequently inadequate, particularly with regard to the instrument, generation of motion and speed of motion. The two measurement methods developed and trialled for the purpose of this study (see Chapter 5) are based upon a summary and further development of the force measurement methods described in the analysed standards.

4.2 Values/force limits stated in standards concerning operating forces for mobile machinery used in agriculture

A comprehensive survey was performed of the current standards governing agricultural machinery with regard to the force limits stated by them. Searches in NoRA (the OSH standards search tool, <http://NoRA.kan-praxis.de/en>) for the German term for agricultural machinery yielded 38 hits. Specific provisions on maximum permissible peak or average values for operating forces were found in 10 documents. The full overview of the existing provisions concerning operating forces can be found in Annex 1. Annex 2 contains a summary of passages concerning operating forces in the standards studied. The provisions concerning

operating forces on agricultural machinery can be grouped broadly in the following categories (see also Fig. 40):

4.2.1 Operation of manually operated parts

The operating force required for moving parts of ladders shall not exceed **200 N** (prEN 16246) at the point of the moving parts intended for manipulation by the operator according to the manufacturer's design and specification.

4.2.2 Grain tank design

If parts or components have to be raised or lowered manually, the required force shall not exceed **400 N** (EN ISO 4254-7).

4.2.3 Swivelling and moving parts

Statements to the effect of that below can be found for example in EN ISO 4254-6, EN ISO 4254-10, EN 707, EN 745, EN 907:

The movement of the foldable components shall be assisted when the required manual actuating force **exceeds 250 N**.

4.2.4 Requirements concerning the steps to the operator's station

The three following statements are essentially found in this context:

1. If parts of the boarding means are movable, the operating force shall not exceed **200 N as the average value** when moving from the start to the stop position. The peak(s) shall not exceed **400 N** (EN ISO 4254-1).
2. The force required for the manual folding operation shall not exceed **250 N** as the average value when moving from the start to the stop position. The peak(s) shall not exceed **400 N** (EN ISO 4254-7)
3. The operating force (for movable parts of the boarding means) shall not exceed 200 N (EN 632).

4.2.5 Clearances of manually operated parts

Statements to the effect of that below can be found for example in EN ISO 4254-1, EN ISO 4254-7, EN 632:

Manually operated parts requiring an operating force $\geq 100 \text{ N}$ shall have a minimum clearance of 50 mm between the outer contours or from adjacent parts of the machine. Manually operated parts requiring an operating force $< 100 \text{ N}$ shall have a minimum clearance of 25 mm. Fingertip controls such as pushbuttons and other electrical switches are excluded from this requirement, provided no risk exists of inadvertent operation of adjacent controls.

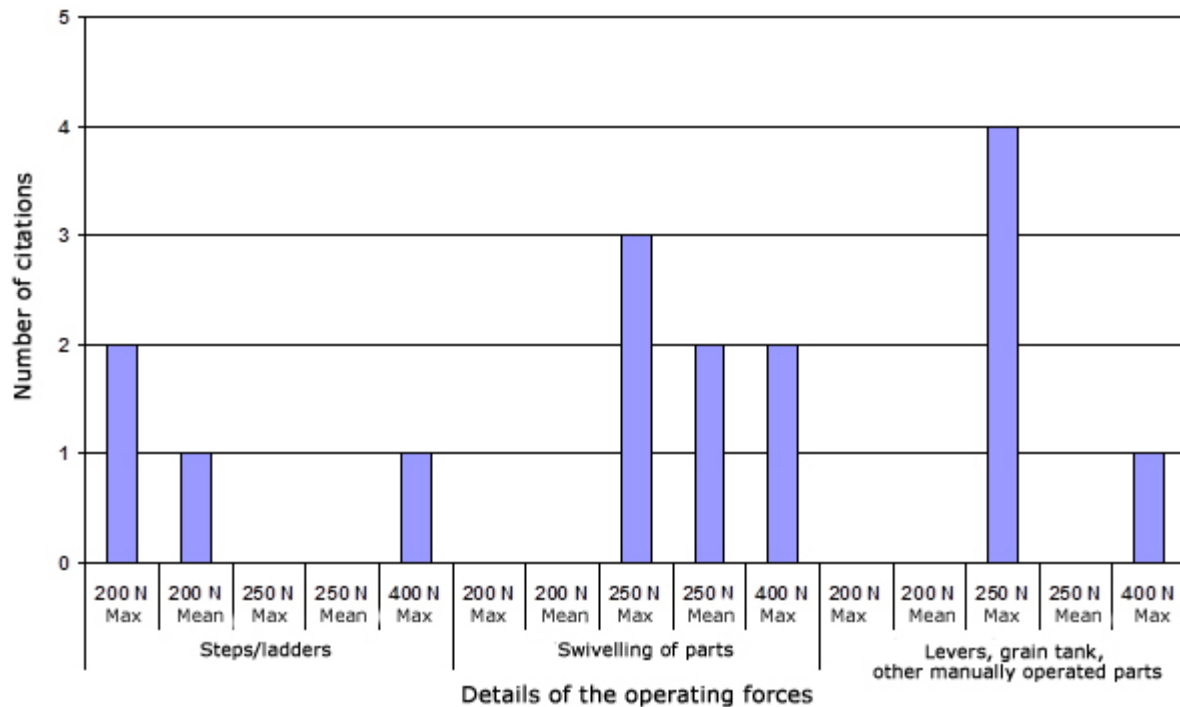

Fig. 40: Frequency of provisions, in agricultural standards, concerning maximum permissible peak or average operating force values for the movement of steps and ladders, the swivelling of parts, and governing levers, the grain tank or other manually operated parts.

During the study upon which this report is based, a selection of the steps, ladders, components and manually operated parts described above were examined.

4.3 Comparison of the force limits in standards with isometric maximum operating forces determined empirically

Up-to-date values for maximum isometric operating forces are available. A cross-sectional study was performed in which the maximum forces exerted in selected force scenarios by a random population sample were measured [22]. Fig. 41 shows mean values for men and women in a number of age groups. The force scenarios involve pulling (with pushing in the opposite direction) on a handle and compression of a hand dynamometer, in both cases under the ideal ergonomic conditions. It was observed that men in the age groups between 15 and 69 are able on average to exert a force of 400 N. Women in the comparable age groups are able to exert only approximately 300 N, around 2/3 of the force exerted by their male counterparts. The great majority of the women in this random population sample would not therefore be able to exert the force of 400 N stated in the standards referred to above. Even under the optimum ergonomic conditions (with ideal gripping height) created specifically for these force tests, approximately 1/4 of the women would not even be able to attain the force of 250 N also stated above. It can be assumed that the maximum values attained are even lower under ergonomically less ideal conditions.

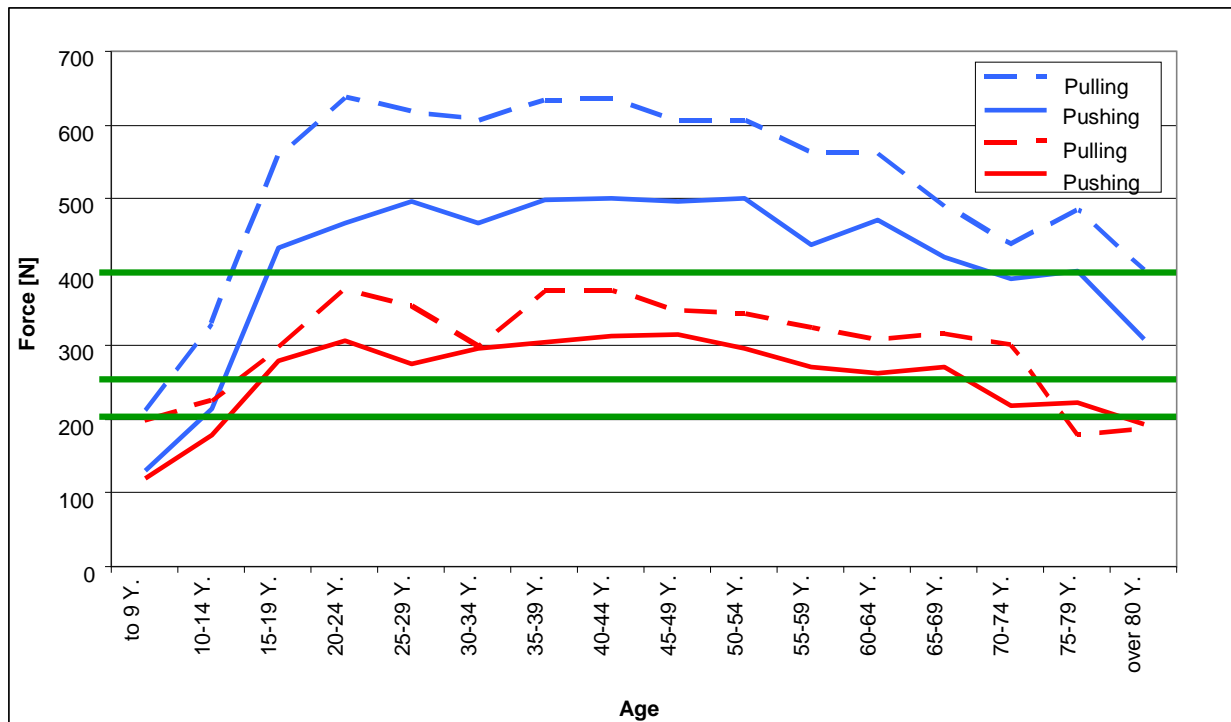

Fig. 41: Values stated in standards for operating forces (lines at 200 N, 250 N and 400 N) compared to maximum forces in a cross-section of the population (782 men, 432 women) [22].

4.4 Review and evaluation of existing reports

Three reports were commissioned by KAN ahead of this study. In these reports, the operating forces on a number of agricultural machines were measured. The results of these reports are compared in a summary below.

4.4.1 What force scenarios were considered?

Operating scenarios were analysed on two combine harvesters from different manufacturers. Consideration was given to:

- Opening and closing of side flaps (in 3 of 3 reports)
- Operation of mechanical levers (in 3 of 3 reports)
- Swivelling of the steps up to the operator's station (in 3 of 3 reports)
- Disengagement of the steps up to the operator's station (in 1 of 3 reports)
- Folding out of the rear ladder (in 1 of 3 reports)
- Removal and refitting of parts of the bodywork (in 1 of 3 reports)

4.4.2 How were the data recorded?

The authors of all three reports used mechanical force meters (see Section 2.3.1), hand-held electronic force meters (see Section 2.3.2), and complex computer-based force measurement systems (see Section 2.3.3). In some cases – where the performance of measurements was not possible – the level of force was also estimated by the assessors (see Table 3).

Table 3: Overview of the methods used for force measurement in the reports

Force scenario	Measurement method*	Report 1	Report 2	Report 3
Opening and closing of side flaps	0		Questionnaire	
	1		Maximum force	
	2	Maximum force (pulling)	Maximum force (pulling/pushing)	Maximum force (pulling)
	3		Force/time measurement (pulling/pushing)	Force/time measurement
Operation of mechanical levers	0		Questionnaire	
	1		Maximum force	
	2		Maximum force (pulling and pushing)	Maximum force (pulling)
	3	Force/time measurement	Force/time measurement (pulling/pushing)	Force/time measurement
Swivelling of the steps up to the operator's station	0	Expert assessment	Questionnaire	
	1		Maximum force	
	2		Maximum force (pulling and pushing)	Maximum force (pulling)
	3		Force/time measurement (pulling/pushing)	Force/time measurement
Disengagement of the steps up to the operator's station	0			
	1			
	2			Maximum force (pulling)
	3			Force/time measurement
Folding out of the rear ladder	0			
	1			
	2			
	3	Force/time measurement		
Removal and refitting of parts of the bodywork	0	Expert assessment		
	1	Weight measurement		
	2			
	3			

* Measurement method: 0 = assessment by questionnaire/expert assessment; 1 = mechanical force meter; 2 = hand-held electronic force meter; 3 = complex computer-based force measurement system

4.4.3 Were reproducible results obtained?

The reports were not produced according to a uniform pattern, and the measured values are therefore also presented differently. It can however be inferred broadly from the three reports that the measurement results are broadly reproducible with the majority of measurement methods and those employed. Depending upon the measurement technology used, the level of force and the complexity of measurement, the deviations in repeat measurements are on average in the order of up to 10%.

The speed of motion was found to be a major factor for poor reproducibility. This was particularly evident when a rear ladder was folded in and out slowly and quickly. Deviations of up to 30% were observed in this case (see Table 4).

Table 4: Values measured during the folding in and out of the rear ladder of a combine harvester (source: excerpt from a report produced for KAN on the operating forces on agricultural machinery)

	Folding out		Folding in	
	Slow	Fast	Slow	Fast
Max.	538 N	613 N	540 N	701 N
Mean	132 N	91 N	165 N	161 N

4.4.4 What recommendations can be formulated based upon the reports?

Two reports conclude that the speed of motion has an influence upon force peaks. One report concludes that the influence of the speed of motion is minor. None of the three reports yields information on monitoring of the speed and direction of motion.

One report criticized that some of the manually operated parts must be operated in ergonomically highly unfavourable postures and that some points of force application were virtually unreachable. Consideration should be given to these aspects in future.

The consensus of the reports was that it is often sufficient for the peak force to be determined during the movement processes. Where force progression is variable (e.g. constantly increasing, or with multiple force peaks), recording of the force/time characteristic is advantageous. One report considers the psychophysical approach to be sufficient for identification of critical conditions in the exertion of force. This is however not very objective. Where the force progression is not constant, electronic measurement methods are beneficial. When the force progression is steady, and when used for mere identification of force peaks, mechanical measurement methods are also adequate. No general consensus exists on what measurement technique should be used under what circumstances.

4.5 Consultation of manufacturers regarding measurement methods used to date

In the course of this study, manufacturers of agricultural machinery were contacted and consulted concerning their experience to date and their procedures regarding the subject of operating forces on agricultural machinery. Some manufacturers who expressed interest were visited, and certain force scenarios examined and measured jointly on site. The instruments and methods employed were regarded by the agricultural machinery manufacturers who were visited as being suitable for use.

All the manufacturers consulted conduct measurements of the operating scenarios, generally on type samples or prototypes. Simple mechanical instruments (spring gauges) and hand-held electronic instruments and, in particular cases, also computer-based measurement systems with strain gauges are employed for this purpose. The measurement method to be used is frequently selected on an ad-hoc basis according to the application and the form of the force.

One manufacturer reported that in some cases the operating forces could be somewhat higher than the limit values because a flap or other manually operated part might have to have a certain self-latching property in use; this was however the exception.

Another manufacturer reported that although in principle the operating forces were always considered, the emphasis lay upon reachability, usability, and the underlying conditions (where and in what way the product or part of a product was used). At the beginning of the design process, gas springs were analysed, weights fitted to levers and grasping points defined, and the lever rule and other theories used for analyses which were then coupled to the usability in practice. A wide variety of instruments, ranging from spring gauges to test subjects, were used for the purpose of testing. Test subjects are essential in particular for the practical usability. Since harmonized measurement methods and procedures do not exist, methods and procedures are selected according to the requirements of the specific scenario. Where forces are too great, hydraulic solutions are developed and implemented.

Other manufacturers also report that staff and instruments are used to trial operating forces on prototypes. The forces arising are frequently analysed beforehand and then measured in tests in practice.

5. Trialling of measurement methods

This chapter describes two measuring instruments and methods (Section 5.1), together with trials performed with these instruments and methods in various operating scenarios. In the practical trials (Section 5.2), the focus lay upon study of the usability; in the laboratory trials (Section 5.3), upon study of the reproducibility of the data. The results were to permit evaluation of the measuring instruments and methods with regard to the practicability and accuracy of measurement of operating forces on mobile (agricultural) machinery.

5.1 Description of the measurement methods used

This section describes the measurement methods used as trialled within the present study. The structure is geared to the aspects from other standards for the measurement of operating forces as described in Section 4.1.2:

1. Measurement equipment (principle of measurement, e.g. measurement apparatus, resolution and trueness of the measurement equipment)
2. Test arrangement, conditions and performance of testing (local conditions [e.g. laboratory, field], temperature, atmospheric humidity, setup, procedure and performance of repeat tests, operating/measurement distance)
3. Definition of the operating force (point of force application and direction of force)
4. Form and monitoring of the generation of movement (manual, gravity-induced or automated)
5. Selection and preparation of the item under test (selection, preparation/treatment)
6. Form of presentation of the results
7. Measurement log and test report

5.1.1 Measurement equipment

For the trialling of measurement instruments and methods, two methods, one simple and one complex, were selected from the measurement instruments described in Section 2.3. These will be described in greater detail below.

5.1.1.1 Measurement equipment for measurement with the simple measurement method employing a hand-held force meter

The "PCE-FG 500" (Fig. 42) was selected as the hand-held force meter. This instrument enables measured values to be recorded and force/time characteristics to be displayed, and features an interface and dedicated software (see Fig. 43).



Fig. 42: PCE-FG 500 hand-held force meter



Fig. 43: Software user interface for the PCE-FG 500 hand-held force meter

This hand-held force meter enables forces in the pulling or pushing direction to be measured and saved at ambient temperatures between $-10\text{ }^{\circ}\text{C}$ and $+40\text{ }^{\circ}\text{C}$ with a maximum error of $\pm 0.05\%$ of the maximum force of 500 N. The resolution is 0.1 N. Dynamographs can be recorded and saved at a sampling rate of up to 40 Hz. The dynamographs can be saved to PC via a serial interface and the software provided, and exported for example in the form of time series in standard spreadsheet application formats (such as Microsoft Excel). The meter is powered either by a power supply or a rechargeable battery.

5.1.1.2 Measurement equipment for measurement by means of the complex measurement method employing a (force) measurement system with dedicated modulation function

The second method trialled here for the measurement of operating forces on agricultural machines is a complex measurement method, substantially more complex than the method already described. The modular force measurement system was set up based upon NextView software with a measurement amplifier (bmcm, Fig. 44), a strain/pressure sensor (ME-Systeme, Fig. 45) and a gradient sensor (Kübler, Fig. 46).



Fig. 44: Force measurement system based upon NextView software with bmcm measurement amplifier



Fig. 45: ME-Systeme strain/pressure sensor



Fig. 46: Kübler gradient sensor

The ME-Systeme KD40S force sensor employed has a rated force of 500 N and a measurement uncertainty of $\pm 0.1\%$ (of the maximum value) over a temperature range from 10 °C to 60 °C. The Kübler type IS40 gradient sensor has a measurement range of $\pm 60^\circ$ at a measurement uncertainty of $\pm 0.5^\circ$ over a temperature range of -30 °C to 70 °C. The NextView software enables the data to be recorded, visualized, logged and interpreted. The measurements were supported by a bmcm MA-UNI measurement amplifier with a resolution of < 0.1 N and a sampling rate of up to 100 Hz over a temperature range of -25 °C to 50 °C. The equipment was powered by a mains power supply.

5.1.2 Test arrangement and conditions and performance of testing

5.1.2.1 Local conditions

The measurements were performed in a number of environments: in farmers' barns, in agricultural machinery manufacturers' showrooms and sales areas, and on the premises of an agricultural machinery dealer.

5.1.2.2 Repeat tests/evaluation/testers

Each test was performed by two testers and in each case at two speeds (slow and fast). Each test permutation was performed five times. The respective peak value recorded on the dynamograph was taken as the result of the measurement, and averaged across all tests.

5.1.2.3 Influence of the climatic conditions

According to equipment manufacturers and descriptions in the standards, no deviations from the accuracy class are to be expected when instruments are operated within the rated range under constant climatic conditions. As described above, the rated temperature range of the instruments selected here lies between 10 °C and 40 °C. The operating temperature range lies between -20 °C and 80 °C. Unfortunately, the manufacturers of the instruments frequently fail to state the recommended atmospheric humidity. The measurements referred to here were all performed within the stated temperature range.

5.1.2.4 Measurement motion and distance

The full operating distance was defined as the measurement distance. Motion was to be natural and steady. The point of force application was always defined as the centre of a handle or knob; where no handles were present (for example on the side flaps of some combine harvesters), the point of force application was defined as the point at which contact is normally made with the panel or other manually operated part.

Where the instrument could not be placed precisely in the centre of a handle or knob, it was placed in the immediate proximity and the distance from the usual point of force application was determined. The forces were then converted as shown in Fig. 47 and Fig. 48.

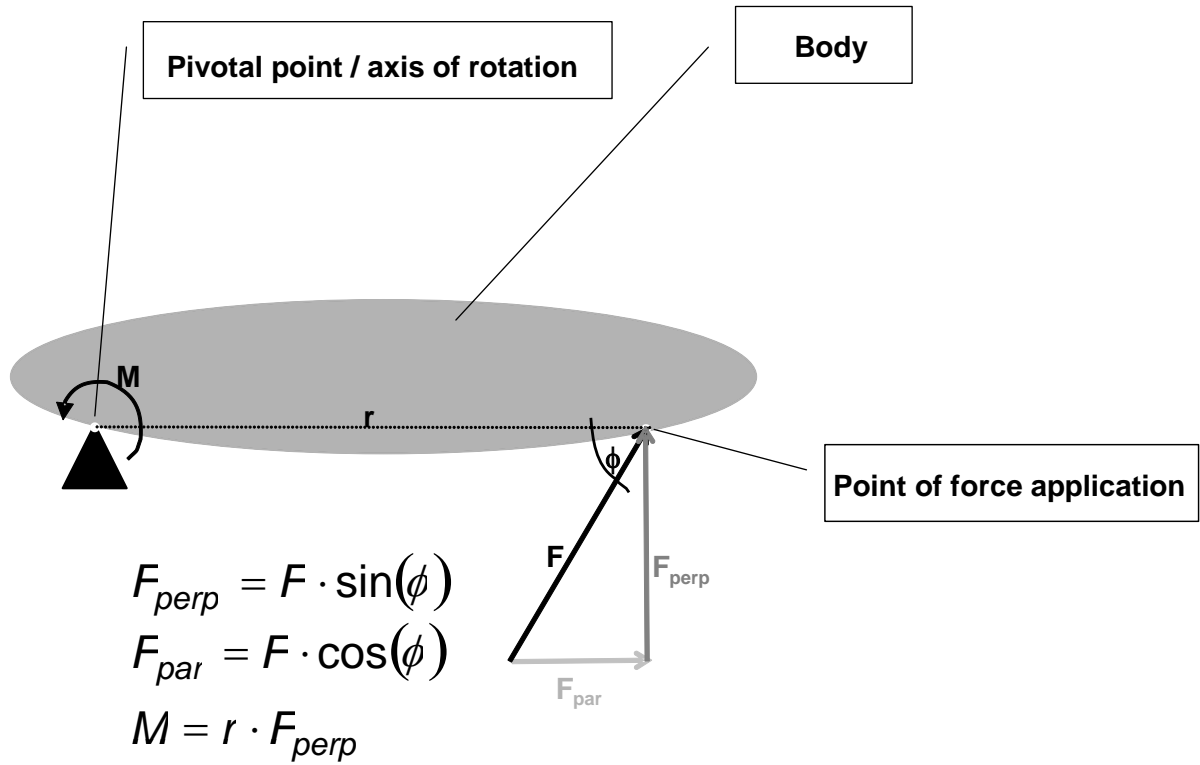

Fig. 47: Definition of the torque and breakdown of the components of a force

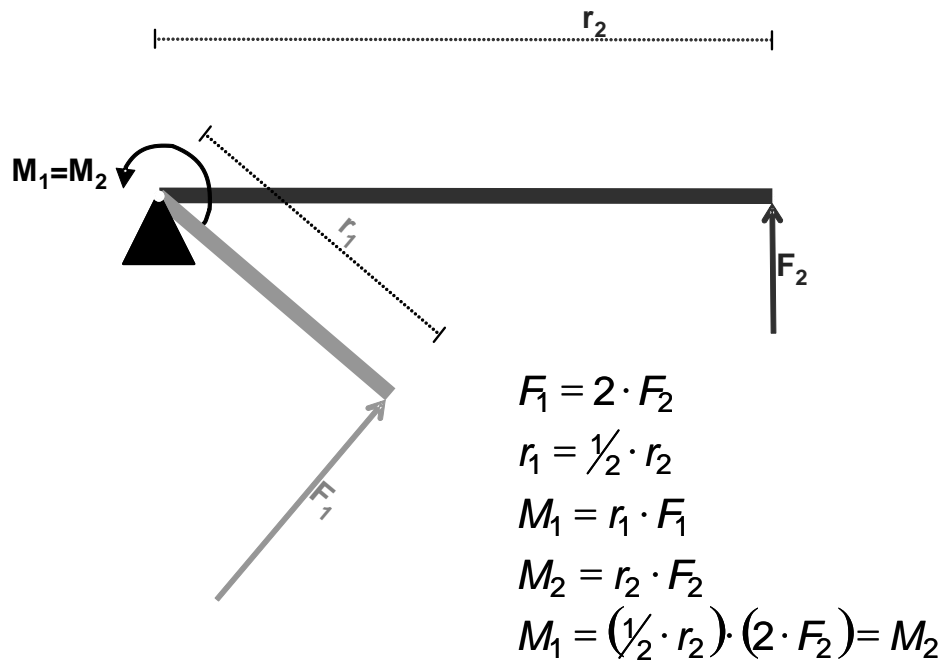

Fig. 48: Example of conversion in consideration of the point of force application

5.1.2.5 Adjustment of the force sensors

The force sensors were adjusted prior to each measurement series, at the beginning of each day of measurement, and following longer interruptions. For this purpose, the weights were weighed by means of the hand-held force meter (calibrated by the manufacturer), and the strain sensor then adjusted in eight stages from 0 N to 500 N. The adjustment was then checked in two stress stages.

5.1.2.6 Adjustment of the gradient sensor

The gradient sensor was also adjusted prior to each measurement series, at the beginning of each day of measurement and following longer interruptions. Adjustment was also performed in two stages: at an angle of 0° (vertical) and at an angle of 90° (horizontal) by means of a spirit level.

5.1.3 Definition of the operating force

In both the simple measurement method described here and in the complex method, the operating force to be determined is perpendicular to the manually operated part (permanent angle of 90°). In the simple method, this direction of force was to be maintained as constant as possible by the tester by careful execution of the movement. For the complex method, the direction of force was corrected mathematically.

In the complex method, the angle of attack of the measured force changes as a function of the travel. In order for the measured rope force to be corrected for its direction of action to the operating force to be determined, i.e. that acting upon the manually operated part in the ideal direction, certain fixed length dimensions must be determined for characterization of the measurement setup under analysis, in addition to continual recording of the angle of the manually operated part (see Table 5). A tape measure with a scale interval of 1 mm was used for the length measurement.

The subsequent procedure is demonstrated with reference to the "closing of a side flap" force scenario. The measurement system records the characteristic of the angle of the manually operated part and that of the rope force synchronously during measurement at a sampling rate of 100 Hz. In other words, for each second of measurement, 100 continual value pairs of the rope force and the corresponding angle of the manually operated part are available. The procedure demonstrated below for correction of the angle must be applied to each of these value pairs. A spreadsheet application (Microsoft Excel) is employed for this purpose during interpretation of the results of the tests. Fig. 49 shows the conceptual test arrangement. For the third spatial dimension (not shown in the image), the points A to D must be imagined as lying on a plane parallel to this spatial direction.

For calculation of the correction, the angle β between the rope and the straight line through the point of force application and the pivotal point must be known.

Provided β is known, the measured rope force F_{rope} can be converted by means of equation 1 to the desired perpendicular actuating force F_{\perp} .

$$F_{\perp} = F_{\text{rope}} \sin(\beta) \quad (\text{Equation 1})$$

For calculation of β , the angle α and the lengths of the straight lines a and c must be known. Since the operating angle detected by the gradient sensor is the angle between the straight lines a and e , i.e. the sum of α and γ , but the angle required for correction is α , the fixed correction angle γ must first be calculated. Subtraction of this angle from the angle detected by the gradient sensor yields the desired angle α .

The following equations demonstrate the procedure:

$$b = \sqrt{d^2 + e^2} \quad (\text{Equation 2})$$

$$\gamma = \arctan\left[\frac{d}{e}\right] \quad (\text{Equation 3})$$

$$\alpha = \text{measured angle} - \gamma \quad (\text{Equation 4})$$

$$c = \sqrt{a^2 + b^2 - 2ab \cdot \cos(\alpha)} \quad (\text{Equation 5})$$

$$\beta = \arccos\left[\frac{a^2 - b^2 + c^2}{2ac}\right] \quad (\text{Equation 6})$$

Equations 2 and 3 for determining γ need be applied only once for each test arrangement; the angle remains unchanged during the measurement movement. Equations 4 to 6 must be applied for each measured value pair of rope force and corresponding angle.

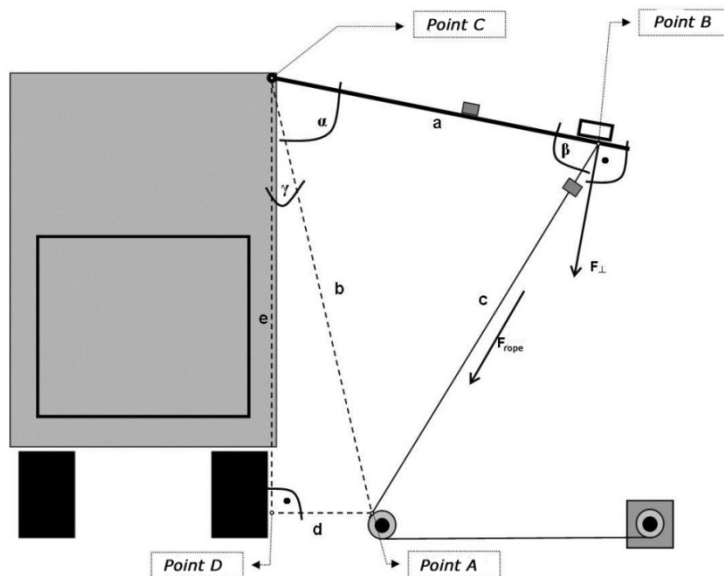

Fig. 49: Schematic test arrangement of the complex measurement method showing the force scenario of "closing of a side panel" with dimensions and angles for correction of the direction of force application (further captions: see Table 5 and Fig. 50).

Table 5: Explanation of the forces, lengths and angles in Fig. 49.

Symbol	Definition
Point A	Point at which the wire rope departs from the fixed pulley in the direction of the manually operated part
Point B	Point of force application of the measurement
Point C	Pivotal point of the manually operated part
Point D	Intersection of the horizontal straight line through Point A and the vertical straight line through Point C
a	Straight line from Points B to C (to be determined by a tape measure)
b	Straight line from Points A to C (calculated)
c	Straight line from Points A to B (changes during the travel; is calculated continually)
d	Straight line from Points A to D (to be determined by tape measure)
e	Straight line from Points C to D (to be determined by tape measure)
α	Angle between a and b (changes during the travel; is calculated continually)
β	Angle between a and c (changes during the travel; is calculated continually)
γ	Angle between b and e (is calculated)
•	Right angle between d and e and between a and F_{\perp} (known: 90°)
F_{rope}	Measured rope force
F_{\perp}	Corrected force in accordance with the given definition of the actuating force

5.1.4 Form and monitoring of the generation of movement

5.1.4.1 Generation of motion when measurement is performed by means of the simple measurement method employing a hand-held force meter

In the simple method, motion is generated manually at high and low speed by the testers. The tester holds the force meter in his or her hands and executes the measurement movement with it by pressing the force transducer against the manually operated part or by pulling on it, in the direction of movement. The test subject is required to perform the measurement movement as steadily as possible and to keep the measurement axis of the instrument constantly in the direction of the movement, perpendicular to the shortest line between the point of force application and the pivotal point of the manually operated part.

5.1.4.2 Generation of motion when measurement is performed by means of the complex measurement method employing a (force) measurement system with dedicated modulation

The measurement motion is generated automatically by a wire rope which, driven by a rope winch and guided over a fixed pulley, is connected to the

manually operated part in the direction of motion. The force is measured by a pulling force sensor connected directly between the loose end of the rope and the point of force application. In addition, the angle of the manually operated part is registered by means of a gradient sensor. Owing to the two measured variables being recorded synchronously, the force actually measured (acting in the direction of the rope attack) can be corrected continually by trigonometric relationships and simple mechanics to the force acting upon the manually operated part in the ideal direction (for the operating task). The measurement arrangement is shown schematically in Fig. 50 for the force scenario of "closing of a side flap". Since motion is generated by the winch, movement can be measured by means of the complex method only in the pulling direction.

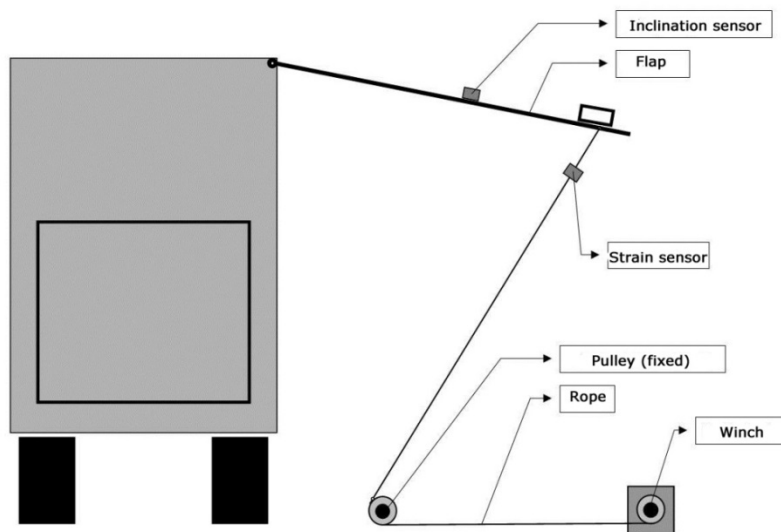

Fig. 50: Schematic test arrangement for the complex measurement method with reference to the force scenario of "closing of a side flap".

In the test arrangement, the position selected for the fixed pulley must be such that the greatest possible range of operating movement can be recorded. If the angle of attack of the rope on the manually operated part is too shallow, the measurement movement will no longer be possible. The length of the pulling force sensor also results in an additional dead rope length of approximately 15 cm. Owing to these effects, motion measurement by means of the complex method is limited to an operating range of somewhat less than 90° in a test arrangement. When the gradient sensor is fitted, it must be ensured that it is aligned such that the axis of measurement and the perpendicular distance between the point of force application and the pivotal point are parallel to each other.

5.1.5 Selection and preparation of the item under test

The tests were performed on new and used machinery.

5.1.5.1 Preparation of the item under test for measurement with the hand-held force meter

During tests performed with the manual force meter, force was transmitted between the force meter and the item under test with use of the attachments provided, or where appropriate, with custom auxiliary material. In order for lateral forces to be avoided, however, the connection between the meter and the item under test must not be rigid. It therefore had to be ensured that the force transmission was decoupled during the measurements (for example by means of hooks, ropes or similar between the meter and the component; see Fig. 51). Observance of the 90° angle is necessary in order to permit comparison of the measured values with the guideline values (see Annex 6). In order for the machine and the manually operated part not to be damaged during performance of the test, small rubber mats were in some cases placed between the meter and the test body (Fig. 52)

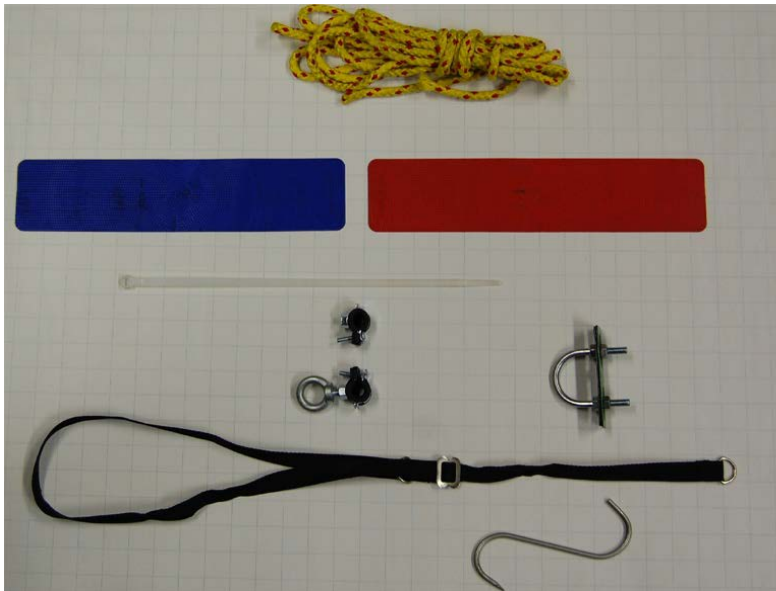

Fig. 51: During force measurement it must be ensured that the force transmission between the meter and the part is decoupled (for example by means of hooks or ropes)



Fig. 52: Use of a rubber mat to prevent damage to paintwork during measurement

5.1.5.2 Preparation of the item under test for measurement by means of the complex measurement method employing a (force) measurement system with dedicated modulation

Preparation is similar to that for the simple method. Refer to Section 5.1.4.2 for the test arrangement. The measurement can be performed only in the pulling direction.

5.1.6 Form of presentation of the results

The results of the measurements are the force/time characteristics of the discrete measurements. The peak values from these results are considered. The final result is the mean of the 10 discrete measurements per studied scenario and measurement method. This is based in particular upon prEN 13561, External blinds and awnings – Performance requirements including safety, which was modified for the applications studied here.

5.1.7 Measurement log and test report

Points 5.1.1 to 5.1.6 stated here were logged for each measurement performed. The name/initials of the tester, the date, a description of the item under test, and all information required for identification of the item under test and the testing equipment used were also documented. Photographs and videos of the tests were also taken. The documentation was based in particular upon EN 12046 Part 1, Operating forces – Test method – Part 1: Windows.

5.2 Trialling of operating scenarios in the field

The two measurement methods described above were first trialled in operating scenarios on a number of agricultural machines on various farms and at the premises of agricultural machinery manufacturers and dealers. The operation of levers, swivelling of flaps, covers, shrouds and components, and the moving of steps and ladders were examined. The focus of the examination lay upon the usability of the measurement methods. Fig. 53 and Fig. 54 illustrate by way of example the operation of levers and measurement by means of the hand-held force meter during the opening of a grain tank. The resulting recorded measured values (force/time diagrams) are shown in Fig. 55.



Fig. 53 and Fig. 54: Opening of a grain tank on a combine harvester (Claas Mega 350). Half a turn is required to open the tank. Measurement by means of a hand-held force meter. Left: test subject 1; right: test subject 2

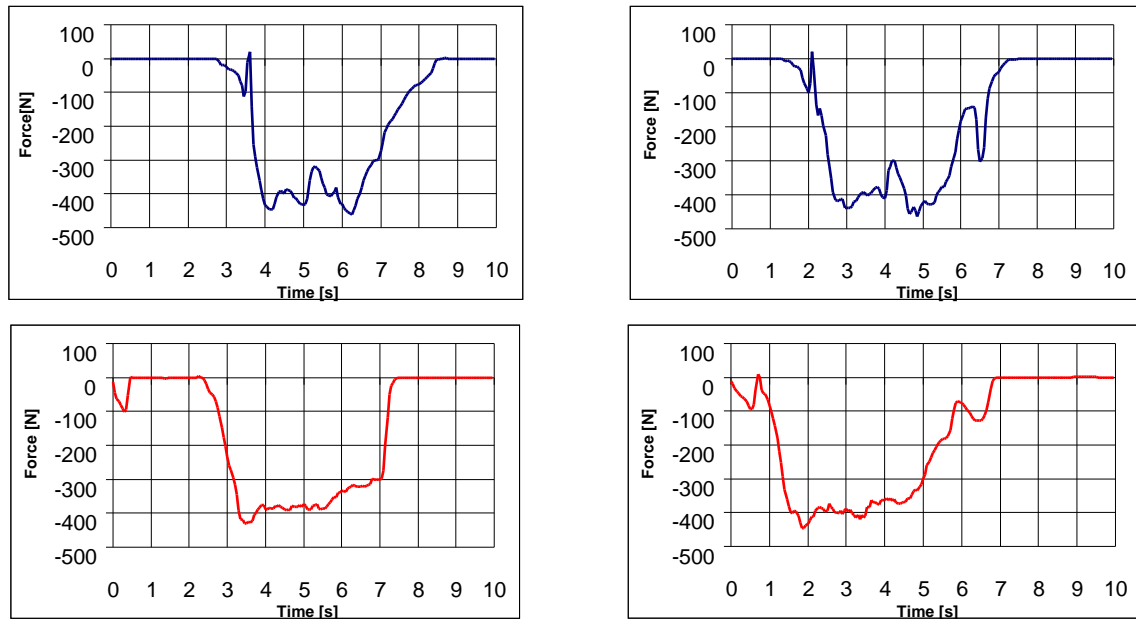

Fig. 55: Force/time diagrams for the opening of the grain tank. Measurement by means of a hand-held force meter. Blue: test subject 1; red: test subject 2

When opening the grain tank, the test subjects had to exert a peak force of up to 450 N¹ and maintain the hand-held force meter as close to perpendicular to the lever as possible in all lever positions. Even under these difficult conditions, the measurements performed yield comparable force characteristics with virtually identical maximum values (see Fig. 55). The point of force application could not be located directly on the knob of the handle in this case, but only a little below it. This results in the lever arm being shortened and higher values being recorded than would be necessary under real-case conditions. For information on conversion, see Section 5.1.2.4.

A comprehensive presentation of the field measurements can be found in Annex 3.

5.3 Trialling of operating scenarios in the laboratory

The studies conducted in the field (Section 5.2) were supplemented by laboratory simulations of a number of operating scenarios frequently encountered in practice. These were undertaken firstly in order to permit better estimation of the reproducibility of force measurements and secondly because the agricultural machinery in use in the field does not enable force meters to be attached effectively in all cases without destruction of or damage to the item under test. The measurements shown below particularly have the function of comparing different measuring instruments and methods and of presenting the influence of

¹ Since the meter could not be positioned precisely in the centre of the knob, the values had to be converted (normal force application point at the centre of the knob = lever length of 28 cm; point of force application at the level of the meter (fixed in this case by means of a hose clip) = 25 cm, hence: $(450 \text{ N} \times 0.25 \text{ cm}) \div 0.28 \text{ cm} = 402 \text{ N}$.)

different test subjects and different speeds of motion upon the measurement result.

The operation of levers, swivelling of flaps, covers, shrouds and components, and the moving of steps and ladders were examined. The focus lay upon the reproducibility of the data delivered by the different measurement methods. For this purpose, modular laboratory force measurement apparatus was used for simulation of realistic force scenarios on agricultural machines. For the operation of levers, a representative lever was attached for this purpose to the force measurement apparatus and the operating resistance simulated by three different gas springs (for details of the gas springs, refer to Annex 4, Section 10.1.5). Each lever was operated five times quickly and five times slowly by means of a winch (automated speed) (Fig. 56) and manually by two test subjects with an electronic hand-held force meter (Fig. 57).



Fig. 56: Operation of a lever. Measurement assembly with winch (automated speed, strain sensor and angle measurement)



Fig. 57: Operation of a lever. Test subject 5 with hand-held force meter. The meter is held at a 90° angle to the lever

Fig. 58 shows, by way of example, four force/time characteristics. The upper graphs show the automated movement performed by a winch. This requires continual angle measurements, since the automated motion brought about by the winch does not enable a constant angle of 90° to the item under test to be maintained. For this reason, the angle between the measurement sensor and the item under test is recorded continually during automated measurement, and the force values subsequently corrected accordingly. The force values shown in the images are those following correction.

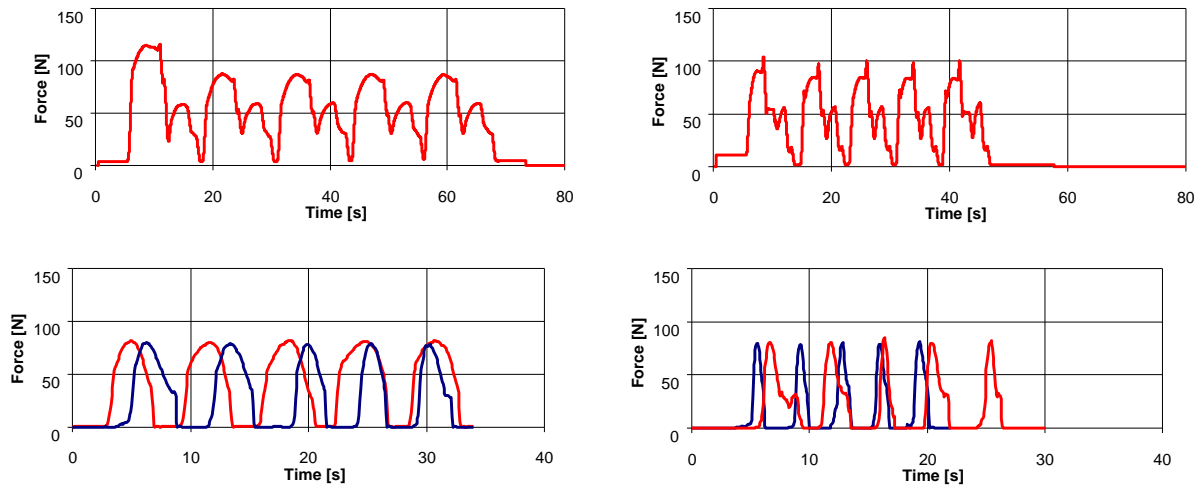

Fig. 58: Operation of a lever, resistance: gas spring 2, five operations, both slowly (graphs left) and quickly (graphs right). Movement with winch (automated speed with angle measurements, graphs top) and manual operation by two test subjects in each case with a hand-held force meter (graphs bottom)

It is notable that the first measurement in the first graph (Fig. 58, top left) differs substantially from the remaining measurements. The reason for this is that when the lever is operated for the first time following a longer break, the gas spring used here is stiffer (by approx. 20-30%) than during frequent operation. A similar phenomenon was also observed during other tests (see Annex 4). Since however this always affects only the first measurement, it is difficult to describe empirically. This will be discussed in greater detail in Chapter 8.

A comprehensive presentation of the laboratory measurements can be found in Annex 4.

Both methods are well suited to use in the field; of the two, the more complex method is by definition more resource-intensive. For example, fixing points for pulleys, the winch, etc. must be found in situ in direct proximity to the machine, and a source of power is required.

In the laboratory tests, the reproducibility was considered with a number of different testers and at different speeds of motion. It was observed here that in particular, the deviations were greater during fast performance of the test than when it was performed slowly. When the tests are performed slowly, the values are substantially closer. Overall, the results of the complex method were found to exhibit the highest reproducibility. This method is however also substantially more resource-intensive than the simple method. When motion is generated as slowly and as steadily as possible by practised testers, however, the simple method can also deliver results with acceptable reproducibility.

The results are described in detail in Chapter 7.

6. Determining of guideline values for maximum forces

The third discrete objective of the study was to provide designers of (agricultural) machinery with guideline values comparing the maximum forces exerted by different operating personnel in typical force scenarios. For this purpose, actual force scenarios on agricultural machines were simulated under laboratory conditions and performed in a number of body postures.

6.1 Methods and test collectives studied for the determining of maximum forces

Within these studies, human physical forces were determined by means of the square method (see Section 2.5). Test subjects were required in this method to increase the force to the maximum within 1 second and then to maintain it for 3 seconds. The isometric maximum force was defined as the mean value in a 2-second interval around the absolute maximum value within this 3-second period. If within these 2 seconds the deviation from the absolute maximum value was greater than 20%, the measurement was rejected.

Eight test subjects in total (four men and four women) took part in the studies. See Table 6 for details of the test subjects.

Table 6: Test collective for determining maximum forces in operating scenarios typically encountered in agriculture

Test subject	Sex	Age	Body height [cm]	Body weight [kg]	General physical force*
1	Male	29	190	100	High
2	Male	35	188	88	Medium
3	Male	52	191	110	High
4	Male	52	187	107	High
5	Female	17	170	60	Medium
6	Female	17	173	65	Medium
7	Female	17	167	50	Low
8	Female	17	167	55	Medium

* Determining of the general physical force is explained in Section 6.2.

6.2 Classification of the representativeness of the selected test subjects

Before the measured force values are presented, it will first be determined here how representative the selected test subjects are. For this purpose, three standardized force scenarios are compared with a random population sample of around 1,200 test subjects of different ages and both sexes. The test data are taken from a survey conducted by Klussmann et al. in 2011 and 2012 [22]. The test employed the mobile force measurement apparatus of the Institute for Occupational Medicine, Safety and Ergonomics (ASER) (Fig. 59 to Fig. 62).



Fig. 59: Mobile force measurement apparatus of the ASER institute for field research. Measurements are possible of hand grip, strain and torsional forces. Mounting of the measurement apparatus on the scissor elevating table enables measurements to be performed in standardized body postures

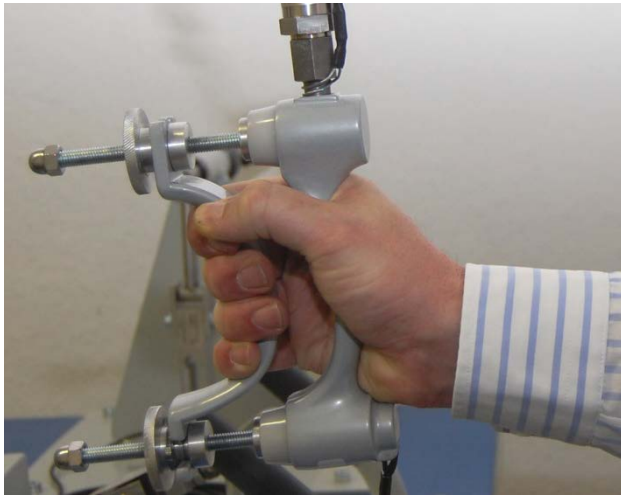

Fig. 60: Measurement of the hand grip force



Fig. 61: Measurement of the pulling force



Fig. 62: Measurement of the torsional force

The force scenarios described here were performed by around 1,200 test subjects under standardized conditions. These test subjects, aged 15 to 60, were regarded as a reference group in the present study. The maximum forces attained for the three force scenarios were divided into tertiles (low, medium and high force) for each sex (see Table 7).

Table 7: Comparison of the maximum forces of a random population sample aged 15 to 60 years in different force scenarios

	Grouping		Pulling [N]	Pushing [N]	Twisting [Nm]
	1st tertile	Low	<271	<247	<3.2
Female (n = 322)	2nd tertile	Medium	271-352	247-294	3.2-3.9
	3rd tertile	High	>352	>294	>3.9
	1st tertile	Low	<500	<404	<4.7
Male (n = 582)	2nd tertile	Medium	500-625	404-497	4.7-5.8
	3rd tertile	High	>625	>497	>5.8

Table 8 shows a comparison of the maximum values exerted by the eight test subjects recruited for the present study with the maximum values of the random population sample.

Table 8: Maximum forces of the test subjects in the comparative measurement

		Pulling		Pushing		Twisting		General physical force*
Test subject	Sex	[N]	Tertile	[N]	Tertile	[Nm]	Tertile	Overall evaluation
1	Male	789	3	619	3	8.1	3	High
2	Male	686	3	400	1	4.8	2	Medium
3	Male	875	3	606	3	6.7	3	High
4	Male	768	3	549	3	5.8	2	High
5	Female	465	3	222	1	2.6	1	Medium
6	Female	337	2	198	1	3.3	2	Medium
7	Female	203	1	214	1	2.9	1	Low
8	Female	411	3	261	2	3.6	2	Medium

* General physical force in comparison with the random population sample (see Table 7)

6.3 Maximum forces for various operating scenarios

This section describes determining of the maximum forces attained in a number of postures and percentage force distributions for the two test collectives described in Section 6.1 (4 men, 4 women). The maximum force value stated is the mean value of the measurements performed. The measured maximum forces and percentage force distributions are shown in Annex 5 Tables 14 to 19.

The maximum force value was determined as follows: for each combination of posture and force direction, three discrete measurements were produced for each of the four individuals in the test collective. The mean value for each posture and direction is thus obtained from 12 discrete values.

The percentage force distribution over each position was determined as follows: for each force direction and test collective, the position with the highest mean force value was identified and made equal to 100%. The forces in the other positions were determined in relation to this highest mean force value.

6.3.1 Operation of levers

Maximum forces were determined for operating scenarios in six force directions: pulling towards the body (B+), pushing away from the body towards the machine (B-), moving sideways to the right/left (C- and C+ respectively) and lifting/pushing the lever upwards (A+) and downwards (A-) (Fig. 63). Each of

these operations was performed in 15 different body postures (see Fig. 64 and Fig. 65, and Fig. 158 and Fig. 159 in the annex): 15 postures were defined in relation to the zero point (back of the right foot). The postures were determined separately by sex according to the range of reach (see DIN 33402-2 [29]). Each measurement was performed by each test subject three times at different times of the day. The measurements were performed within a week under comparable climatic conditions (temperature: 20-22 °C, atmospheric humidity: 46-54%). The measurement apparatus was a single-component measurement system in which the perpendicular force acting upon the sensor was measured.

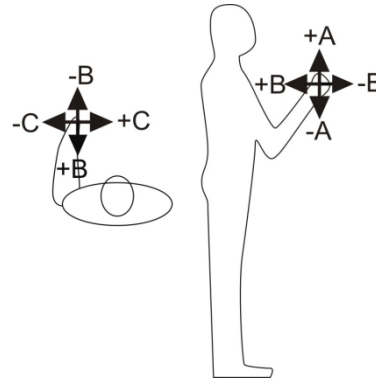

Fig. 63: Presentation of the directions of force, body symmetry plane

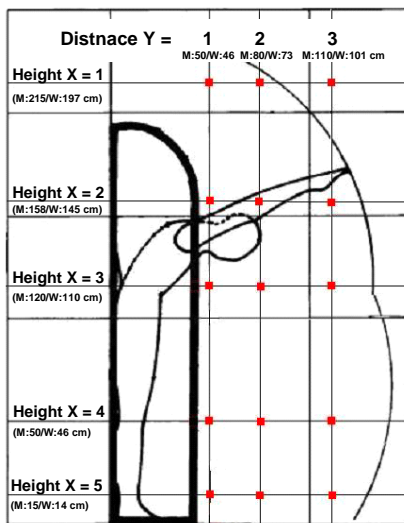

Fig. 64: Presentation of the co-ordinates of the lever positions in relation to the test subject's body



Fig. 65: Measurement arrangement for lever measurements. In this example: measurement at the position X=2, Y=2

6.3.2 Swivelling of flaps, covers, shrouds and other components, and moving of steps and ladders

Maximum forces were determined for the opening and closing of flaps. Three different installation heights were considered for this purpose, and the flaps measured in three positions (90°, 45° and 0°). Each measurement was performed three times by each test subject. The measurements were performed

on a single day under comparable climatic conditions (temperature: 20-22 °C, atmospheric humidity: 46-54%).

The measurement technology employed was the 3D hand force measurement sensor (IFA/Kistler). The diameter of the handle is approximately 35 mm, the width of the handle approximately 110 mm. The handle is mounted in an assembly with an inside clearance of approximately 125 mm and outside dimensions of approximately 180 mm. The assembly also contains the sensors, the values of which are transmitted via the connecting cable to the analysis unit. Fig. 66 shows mounting on a flap.

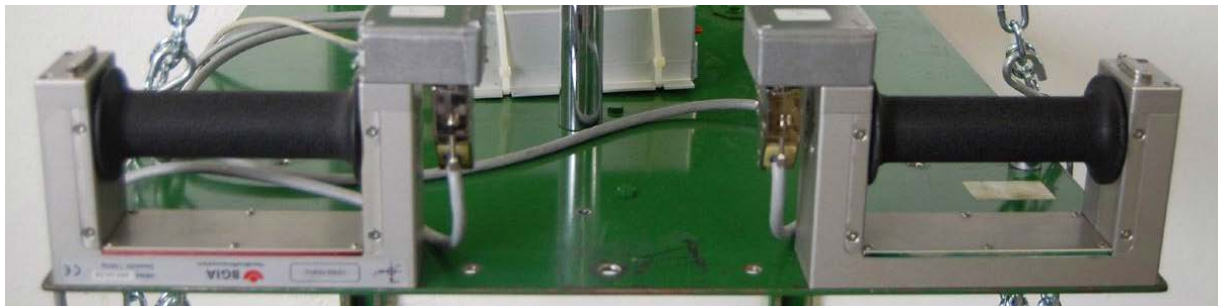

Fig. 66: 3D hand force measurement system (IFA/Kistler) – example of mounting

The maximum forces exerted during the movement of steps and ladders were determined in the same way as the maximum forces for the swivelling of flaps. The maximum forces exerted by the men and women during the engaging and disengaging of ladders were determined. A peak value was also determined, since in practice ladders are typically disengaged/engaged by a jerking movement. The complex force components in the direction of motion were considered in each case.

A comprehensive presentation of the measured maximum force values can be found in Annex 5.

Isometric maximum forces were determined on 8 test subjects (4 male, 4 female) in 3,192 measurements performed in 133 postures. Compared to a random sample of the male population (males aged between 15 and 60), the male test collective is of above-average strength. Compared to a random sample of the female population (females aged between 15 and 60), the female test collective can generally be considered to be of average to slightly below-average strength. The measured force values were presented in table and graph form (Annexes 5 and 6 respectively). The results are described in Chapter 7.

7. Summary of the results

7.1 Summary of the results from the measurements conducted in the field concerning the usability of the methods

In the first instance, the measurements conducted in the field on agricultural machines had the function of examining the usability of the complex and simple measurement methods under practical conditions. The results are documented in Annex 3. Both methods are well suited to use in the field; of the two, the more complex method is by definition more resource-intensive. For example, fixing points for pulleys, the winch, etc. must be found in situ in direct proximity to the machine, and a source of power is required. Manual measurement with the hand-held force meter was always performed by two test subjects; manufacturers (designers) of agricultural machinery were also involved on site. The hand-held method was considered substantially more practicable, not least because testing with the complex method was rarely possible non-destructively and without damage to paintwork, besides being more resource-intensive. The complex method is therefore suitable for use within manufacture (for example for tests on prototypes), but only to a limited degree in the field on machines ready for sale or already in use. Owing to the problems presented by the underlying conditions (the agricultural machinery was available for only a limited time), testing was not always performed precisely nor was a minimum number of tests always observed. The results obtained and shown in Annex 3 should not therefore be considered representative. They are nevertheless broadly comparable (see Table 11 to Table 13 in Annex 3).

7.2 Summary of the results from the laboratory measurements concerning the reproducibility of the methods

Owing to the difficulties associated with the underlying conditions in practice as described above, selected application scenarios were simulated in the laboratory, giving consideration to the aspects of motion speed during the exertion of force, performance by different testers, and differences between measurements obtained during pulling and pushing. The measurements are documented in Annex 4.

Consideration was first given to whether the speed of motion during the exertion of force and performance of testing by different testers had an influence upon the measured force levels. For this purpose, all tests (see Annex 4 for documentation) were performed at two different speeds and in the case of the manual method by two different test subjects. No significant differences were observed here in the measurements performed with the complex method, in which the speed was automated by means of a winch (see Fig. 67 showing a selection of the measurements performed by means of the complex method).

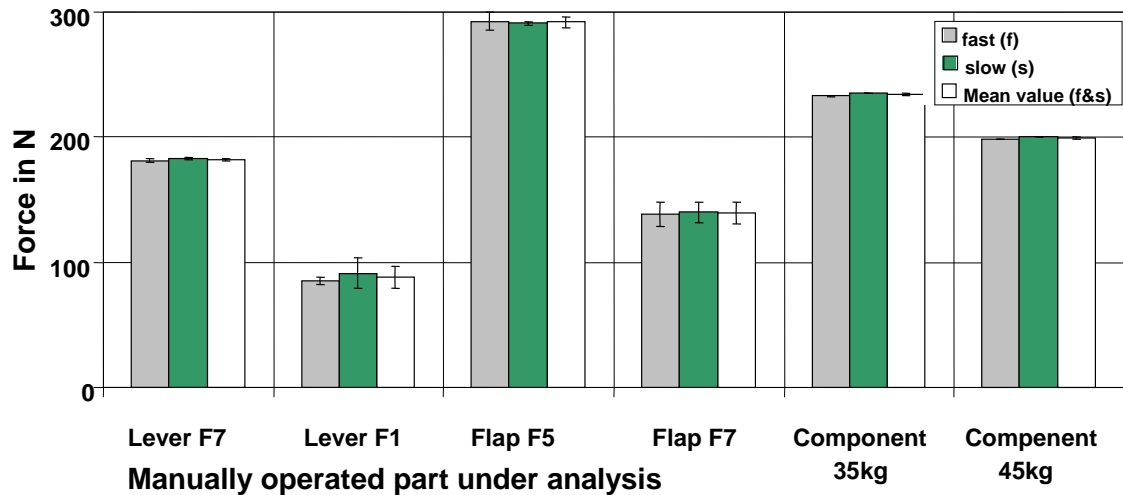

Fig. 67: Measurement by means of the complex method: the level of force and simple standard deviation in different force scenarios, averaged over five times slow performance of the test, over five times fast performance, and over both. The codes "F7", "F1", etc. after the names of the manually operated parts indicate the resistances employed (different gas springs, see Annex 4, Section 10.1.5)

Since only very minor differences were observed, the value averaged over fast and slow performance of the test was used as a reference value for further consideration of the influence of the speed. The measurements obtained during fast and slow performance of the test with the simple method (hand-held force meter and two test subjects) are compared with this reference value in Fig. 68 and Fig. 69 respectively. The measurements shown constitute a selection of all operating scenarios studied.

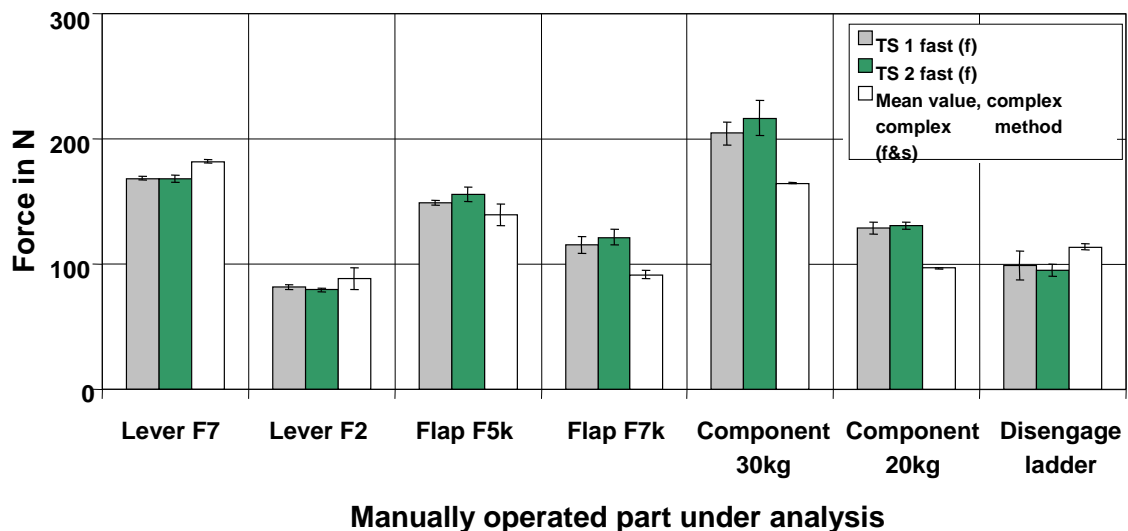

Fig. 68: Measurement by means of the simple method: the level of force and simple standard deviation in different force scenarios, averaged over five tests each for test subject 1 and test subject 2 with fast performance of the test and comparison with the force averaged over fast and slow performance of the test with the complex method. The codes "F7", "F2", etc. after the names of the manually operated parts indicate the resistances employed (different gas springs, see Annex 4, Section 10.1.5). The code "k" after "F5" and "F7" indicates a shortened installation position

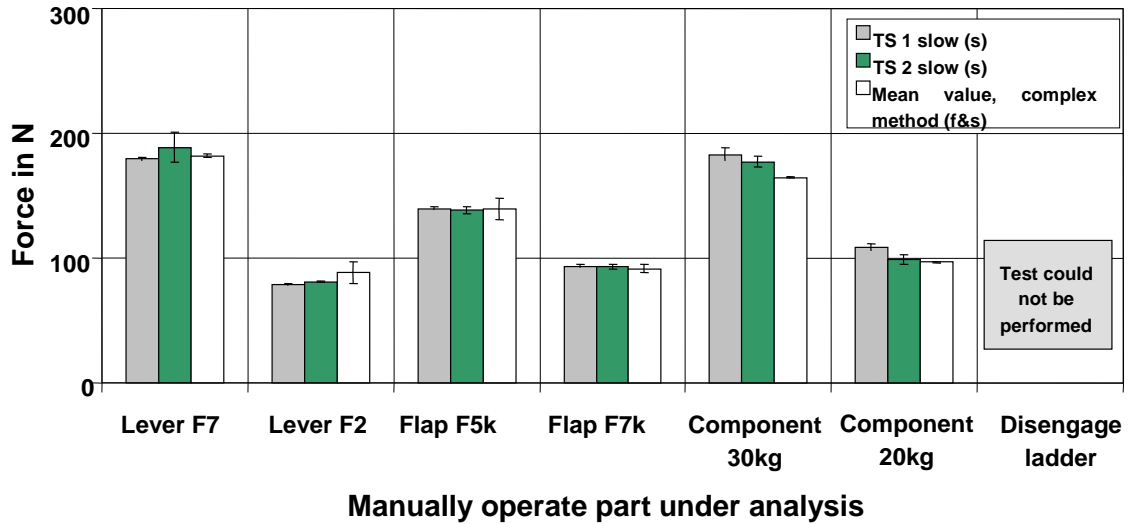

Fig. 69: Measurement by means of the simple method: the level of force and simple standard deviation in different force scenarios, averaged over five tests each for test subject 1 and test subject 2 with slow performance of the test and comparison with the force averaged over fast and slow performance of the test with the complex method

The standard deviation of repeatability S_r and the standard deviation of reproducibility S_R are employed as dimensions of precision with reference to ISO 5725-2 [31] for quantification of the reproducibility of the two methods.

Table 9: Standard deviation of repeatability S_r and standard deviation of reproducibility S_R of the methods averaged over specific force scenarios and over all force scenarios. Note: where fields are greyed out, no force measurements were performed, since this was either not technically possible or not applicable

Measurement type	Lever		Close flap		Disengage ladder		Engage ladder		Heavy part (pulling)		Heavy part (pushing)		Overall mean	
	S_r [%]	S_R [%]	S_r [%]	S_R [%]	S_r [%]	S_R [%]	S_r [%]	S_R [%]	S_r [%]	S_R [%]	S_r [%]	S_R [%]	S_r [%]	S_R [%]
Manual, fast	3.4	3.6	4.6	12.5	9.2	9.2	11.9	15.0	4.1	11.3	3.4	4.0	6.1	9.3
Manual, slow	2.3	3.1	3.5	4.2					1.8	2.9	3.0	5.2	2.6	3.9
Complex	3.8	4.0	4.9	5.0	2.2	2.2			0.2	0.6			2.8	2.9

The deviations are particularly seen to be greater when the test is performed quickly compared to when it is performed slowly (see Fig. 68 and Fig. 69 and Table 9). During slow performance, the values are much closer together. Overall, the results of the complex method were found to exhibit the greater reproducibility. This method is however substantially more resource-intensive than the simple method. When motion is generated as slowly and steadily as possible by practised testers, acceptable reproducibility can also be achieved by the simple method (see Table 9). Use of the simple method in the tests yielded

values that were for the most part identical to or higher than those obtained by the complex method. This can be explained by the fact that with the simple method, the required 90° angle between the hand-held force meter and the component cannot always be maintained perfectly during the movement, as a result of which higher values arise owing to the displacement in angle. With five measurements in each case and with experienced testers, highly reproducible results can however be obtained. In some cases (see for example Fig. 68, "lever F7" and "lever F2"), the maximum values obtained with the simple method were lower than those obtained with the complex method; this could be due to the fact that the measurements were first performed with the complex method and then with the simple method, as a result of which the resistance of the spring deteriorated slightly with increasing number of movements. In the study of the ladder (see Fig. 68, disengagement of the ladder), no correction was made to the angle during measurement with the complex method, which explains the differences in maximum values between the two methods.

The difference between pulling and pushing measurements on the part in the same direction of motion was also considered in the surveys. This is shown in Fig. 70 and Fig. 71 below with reference to the example of choppers.

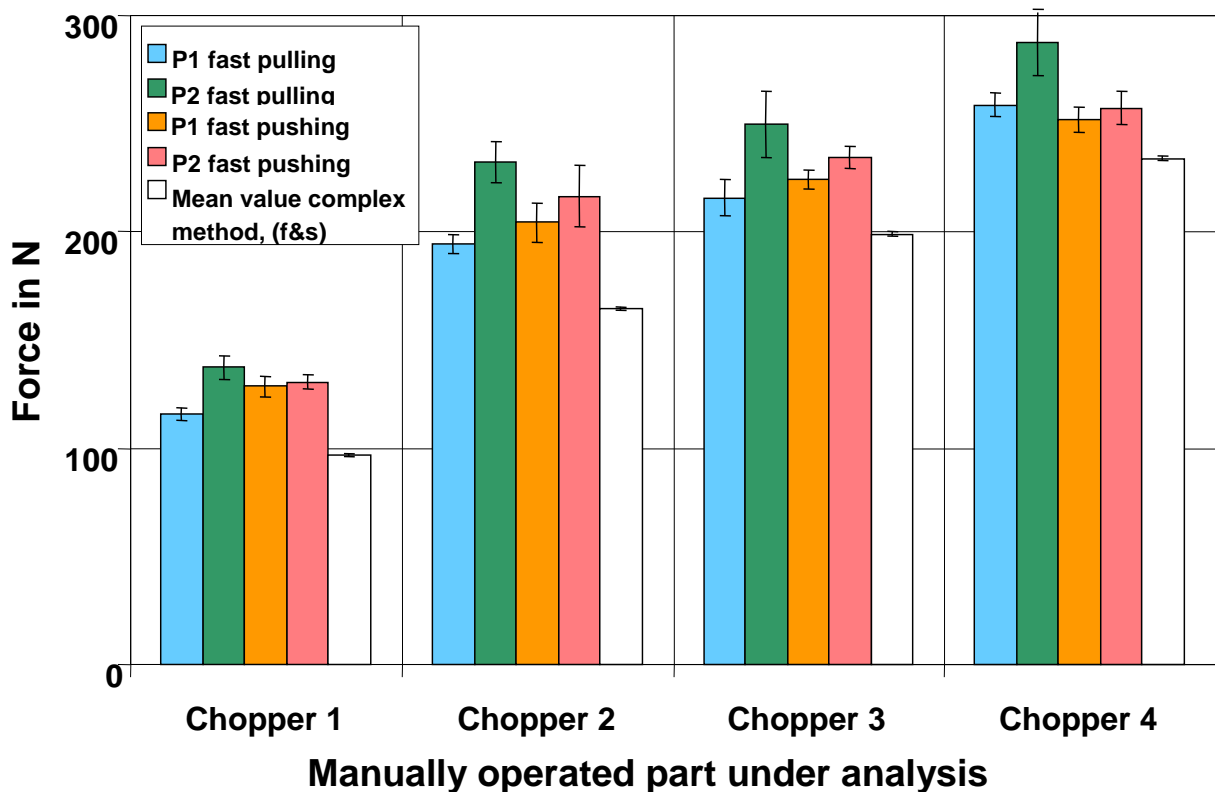

Fig. 70: Performance of pulling and pushing force measurements on the "chopper" component in four weight classes, in each case by two test subjects using a hand-held force meter and in each case pulling and pushing with fast motion, compared to measurement with the complex method

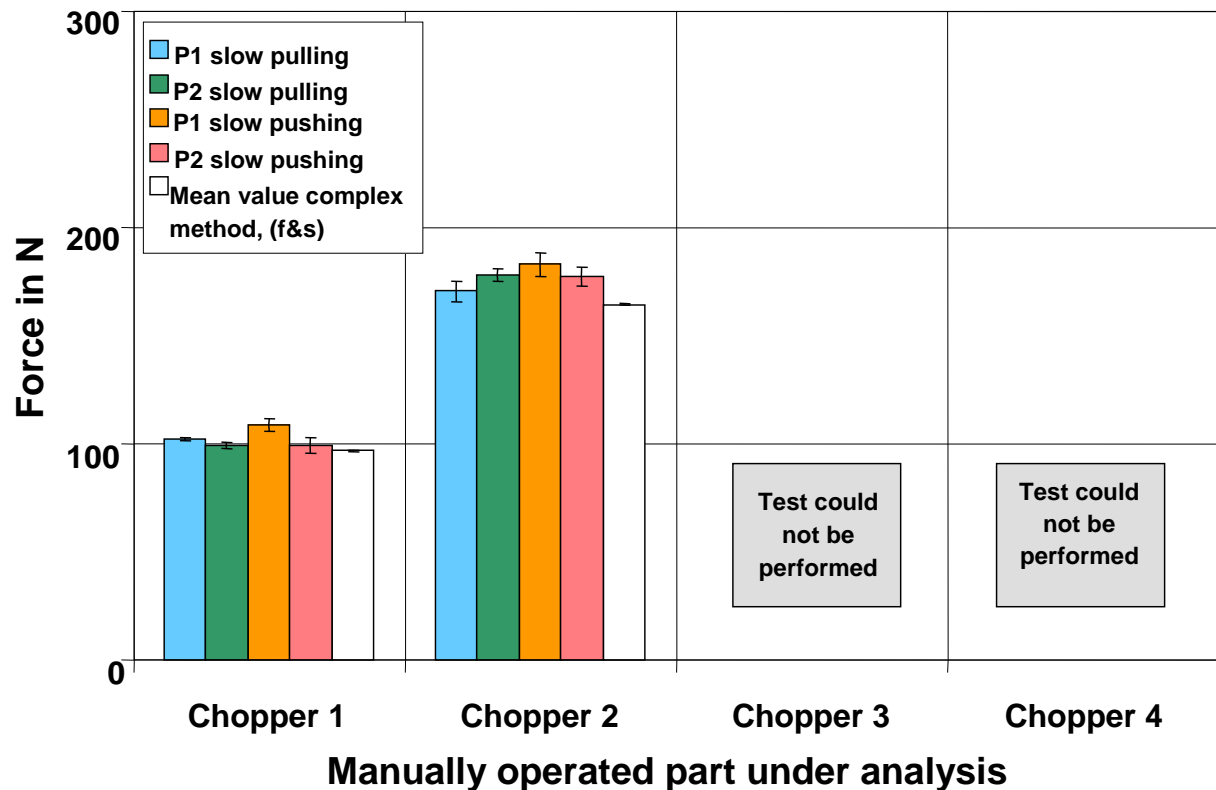

Fig. 71: Performance of pulling and pushing force measurements on the "chopper" component in four weight classes, in each case by two test subjects using a hand-held force meter and in each case pulling and pushing with slow motion, compared to measurement with the complex method Note: The slow motions could not be performed on the heavy choppers (choppers 3 and 4)

The differences are smallest when the test is performed slowly; this is however extremely hard work, particularly on heavy components, with the result that the test subjects were not able to move the heavy choppers slowly. The deviations can be explained essentially by the fact that in the simple method, as described above, the required 90° angle between the hand-held force meter and the component could not always be maintained cleanly during the movement, with the result that higher values arise owing to the displacement in angle. This is more difficult to control with fast movements than with slow motion. The difference between pushing and pulling force measurement is however negligible.

7.3 Summary of the guideline figures determined for maximum forces

Eight test subjects (4 male, 4 female) were available for a period of 5 days per group for performance of the maximum force measurements. Isometric maximum forces for various body postures were determined in these tests. Altogether, 3,192 measurements were performed in 133 positions. Compared to a random sample of the male population, the male test collective was of above-average strength. Compared to a random sample of the female population, the female test collective can generally be considered to be of average to slightly

below-average strength. The force values obtained in the measurements are shown in Annex 5. Simplified images were produced from the measurements that reflect the force levels attained in 6 different categories. Fig. 72 shows by way of example the maximum force levels attainable when manually operated parts are operated, as a function of their position. The graphs produced in this way are all presented in Annex 6.

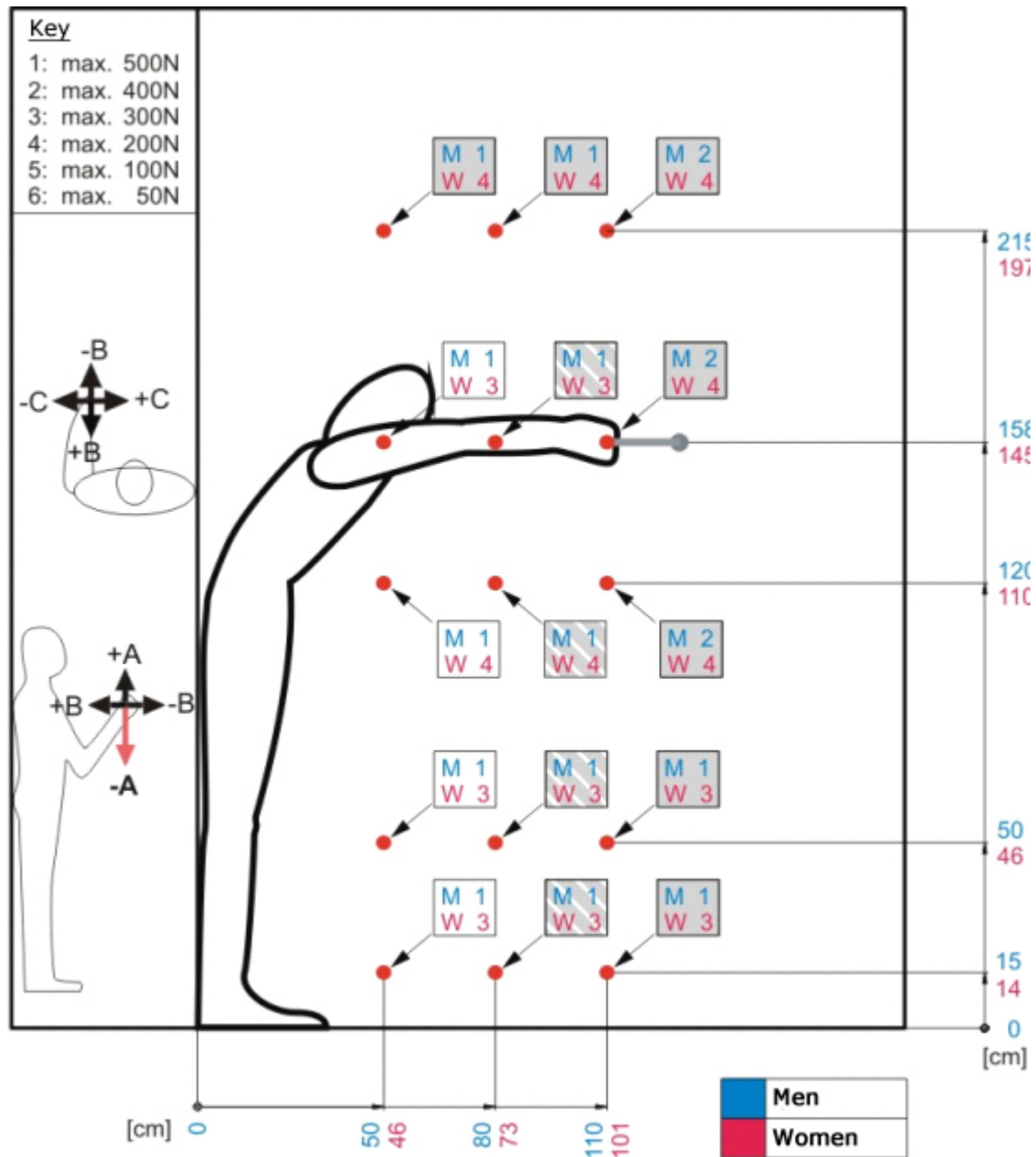

Fig. 72: Guideline values for maximum forces (men and women) for the force scenario of pushing/pulling the manually operated part upwards (direction of force A-), one-handed operation. Areas highlighted in grey are at or beyond many people's reach and are not recommended

8. Findings and recommendations

8.1 Findings

8.1.1 Findings from the measurements of operating forces in the laboratory and in the field

Both measurement methods trialled are in principle suitable for measuring operating forces on mobile agricultural machinery. As can be clearly seen from the laboratory measurements (refer for example to Annex 4, Fig. 142 to Fig. 147), the force scenarios are relatively well reproducible and the measurements of the five repetitions are very similar. Only where the forces to be measured are very low do greater irregularities occur (refer for example to Annex 4, Fig. 146). The maximum force values with slow automated movement, fast automated movement and slow manual movement are very similar. Only with fast manual movement are the values measured around 20-30% higher than those for the other three forms of movement.

It is crucial to the performance of force measurements that the force measurement apparatus (sensors, force meter, etc.) always be decoupled from the item under test and be guided at an angle as close as possible to 90° to the item under test. Where force measurement is automated by means of a winch, continual observance of the 90° angle is not generally possible. A goniometer must therefore be integrated and the measured force values subsequently corrected. This makes performance of the measurements substantially more resource-intensive. Where measurements are performed manually by means of a hand-held electronic force meter, this resource-intensive angle correction is not required, since the 90° angle can be maintained during the movement by skilled handling of the instrument. Inaccuracies may however also arise in this case. The values obtained by manual measurement are for the most part equal to or higher than those attained by automated measurement. Where the measurements are performed by practised test subjects, the differences between the results and those obtained by the complex method may be regarded as negligible. For the majority of measurement scenarios, the use of a hand-held electronic force meter would appear adequate. The one-dimensional measurement at a 90° angle described here results in forces being measured during movement of the manually operated part that are lower than those actually exerted by the operator when the angle between the operator's arm and the lever during movement is not 90°. This is however negligible if these forces are compared with the reference values in the guideline tables (Annex 6), since the latter were obtained in the same way.

8.1.2 Conclusions from the measurements concerning guideline values for maximum forces

During the determining of maximum forces in the various positions and directions of force, it became very evident that the attainable maximum force values vary widely depending upon the body posture to be assumed. High forces

may in particular be attained where the body weight can be brought to bear (for example during pushing) or where for example the force of the leg muscles can be exploited during lifting. In addition, considerable differences arise between the two test collectives, owing (in part but not only) to the substantial difference in weights. On average, the women were able to exert only 1/2 to 2/3 of the maximum forces exerted by the men. This ratio is however not incidental, and has already been confirmed by a number of studies. The reason is the generally lower proportion of muscle mass in the women compared to men, besides the women's lower (on average) body mass.

8.2 Recommendations

8.2.1 Recommendations for measurement methods for operating forces

8.2.1.1 Measurement equipment

The authors recommend that hand-held electronic force meters (see Section 2.3.2) be used for force measurements in the field, since this method is highly practicable. Mechanical spring gauges, as described in Section 2.3.1, are less suitable, one reason being that they show only the maximum values, and are not able to identify artefacts.

When the complex measurement method is used (see Section 2.3.3), the automated operating movement (generated by a winch) may give rise to vibration (as described for example for the field measurements on the chopper) that falsifies the measured value. A complex measurement method, as tested here, does however offer benefits. For example, it also enables force/angle characteristics to be presented (see Fig. 73). The use of this method is recommended for more detailed analyses, for example those performed during machine development.

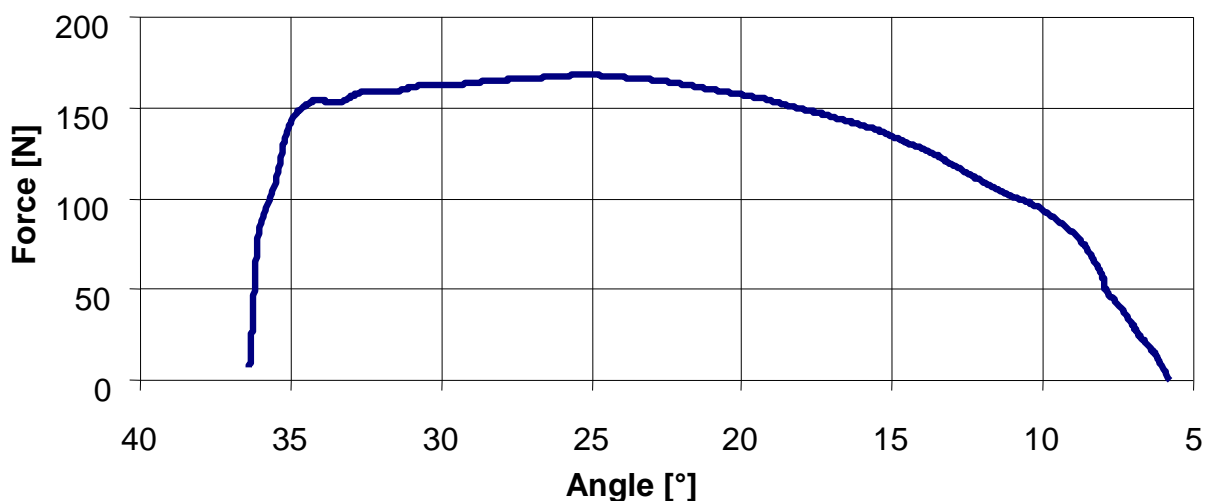

Fig. 73: Force/angle characteristic with reference to the example of closing of the side flap of a combine harvester

The following must be considered during selection of the instrument (irrespective of whether a simple or complex instrument is selected):

- Recording of the force/time characteristic must be possible
- The measurement range must extend to at least 500 N
- The maximum error must be <0.5% of the maximum value
- The sampling rate must be at least 20 Hz, in order to permit presentation of transient force peaks
- The instrument must be suitable for the anticipated temperature range (generally from 0 to 40 °C)

The force sensors must be adjusted prior to each measurement series and following longer interruptions. For this purpose, the force measurement apparatus must be tested with at least two weights. In order to stabilize the signal and to prevent measurement from being influenced by the temperature, the measurement system must be operated at idle for approximately 15 minutes prior to performance of the tests. This enables the electronics to adapt to the prevailing ambient conditions.

8.2.1.2 Test arrangement and conditions and performance of testing

The test arrangement must be set up as described in Section 5.1.

The spatial conditions should reflect those occurring in practice. Each test must be performed five times by two practised test subjects. Before each test, each tester must move the component several times in order to become familiar with the movement. This is important firstly in order for the instrument to be oriented continually as perpendicularly as possible to the manually operated part for the duration of the movement, and secondly in order to eliminate sticking of components when moved for the first time after a longer period at rest.

The point of force application is defined by default as the centre of a handle or knob; where no handles are present (for example on large side panels of some combine harvesters), the point of force application is defined as the point at which contact is normally made with the panel or other manually operated part.

The measurements must be performed at temperatures of between 10 °C and 40 °C. Unfortunately, the manufacturers do not generally issue recommendations concerning the atmospheric humidity. Overall however, the influence of the climate upon the test result can generally be considered negligible.

8.2.1.3 Definition of the operating force

The operating force to be determined lies perpendicular to the manually operated part (permanent angle of 90°). This direction of force must be kept as constant as possible (manually) or corrected. It must be ensured during measurement that the force transmission is decoupled (for example by means of hooks, ropes or similar between the meter and the part). Observance of the 90° angle is necessary in order to permit comparison of the results with the guideline values (see Annex 6).

Where the instrument cannot be placed precisely in the centre of a handle or knob, it must be applied offset. The results must then be converted in accordance with the law of the lever (refer also in this context to Section 5.1.2.4).

8.2.1.4 Form of motion generation and monitoring of it

Motion should be natural and steady. Parts such as ladders which are engaged in position or disengaged by means of a very short jerk are an exception. When the movement is generated manually, control is subject to the impression of the test subject. Where the movement is generated automatically, this factor is controlled by the use of a winch. The full operating distance is defined as the measurement distance.

8.2.1.5 Selection and preparation of the item under test

Whether the measurement results are to reflect ideal, realistic or aggravated conditions (such as soiling) is a decisive question for selection and preparation (e.g. maintenance) of the item under test. EN 12046 Part 2, Operating forces – Test method – Part 2: Doors, recommends that measurements be performed on as-new type samples ready for use. This recommendation however fails to take into account that parts on agricultural machinery may become stiffer over time as a result of soiling or rusting. This is virtually impossible to measure empirically and quantify robustly. The problem of the greater stiffness of parts operated for the first time after a longer period has already been discussed in a report produced in the run-up to this study (see Section 4.4). The recommendation in the report referred to was that the lever be moved a few times before the test is performed. EN 13527 and EN 12046-1 for example likewise recommend that an item under test be moved through its full range of travel once or several times prior to testing.

In order to keep increasing stiffness to a minimum, manufacturers are advised – where they do not already do so – to provide information in the maintenance recommendations for their machines on how stiffness of operation can be prevented by maintenance measures. Where the manufacturer cannot guarantee that the component under consideration is unlikely to become stiffer over time, the authors recommend that the operating forces measured be increased by a margin of 20% to 30% of the measured value or by 50 Newtons, whichever is higher. This recommendation is however based solely upon observations in the laboratory and field studies, and is not empirically robust.

8.2.1.6 Form of presentation of the results

The overall result of measurement was formed by averaging of the discrete peak dynamograph values from all 10 tests.

Consideration should be given to the permissible magnitude of the maximum scatter within a single measurement pass (of 10 tests) and to how possible

outliers should be treated. It is recommended that measured values deviating from the mean value by more than 20% be ignored.

8.2.1.7 Measurement log and test report

The test report should document at least the aspects addressed in Sections 5.1.1 to 5.1.6. The name/initials of the tester, the date, a description of the item under test, and all details required for identification of the item under test and the testing equipment should also be documented. Photographs and videos of the tests should also be produced. A useful basis for the documentation of tests is for example that found in EN 12046 Part 1, Operating forces – Test method – Part 1: Windows.

8.2.2 Recommendations for maximum force limits

The generic force values found in standards governing agricultural machinery are untenable. They fail to take account of differences resulting from the physical location of the manually operated part. The generic value of 400 N stated in the standards also considerably exceeds the physical performance of the majority of women in almost all operating scenarios. The recommended force limits must be considered in relation to the location of the manually operated part concerned, the form of the force and the direction in which it is exerted. In order to assist the manufacturers of mobile agricultural machines, the authors propose that guideline values for maximum force levels be formulated. The tables shown in Annex 6 on this subject were produced based upon the force measurements performed to date. The authors recommend that these tables be made available to machinery manufacturers together with the recommendations formulated here on force measurement methods, in order for them to be trialled in the field and their practicability tested. The values for the weaker user groups should be given consideration during the design of machinery. Should these tables be found useful, further measurements should be performed in order to substantiate the measured values. For other force scenarios for which values were not obtained, it is recommended that the values shown here be extrapolated to them. The same applies to combinations of force scenarios. Should for example simultaneous pulling and pushing be necessary, as shown for example in Fig. 34 for the swivelling of a ladder, the maximum value shown in the tables should be reduced accordingly.

Attention is drawn at this point to the fact that these tables, which are intended to provide guidance, are able to provide information only on the "performability" of the task, and are of only limited suitability for evaluating the "tolerability" (refer in this context also to Section 2.1). They should therefore be applied only for operating scenarios that generally occur only a few times a day. For tasks occurring frequently, the values shown in the tables would have to be reduced. EN 1005-3 [2] proposes three categories for this purpose: multiplication of the value by a factor of ≤ 0.5 (recommended zone), by a factor of ≥ 0.5 to 0.7 (not

recommended zone), and by a factor of > 0.7 (zone to be avoided). The standard does not state the basis for these reduction factors. In order to permit estimation of the stress upon the musculoskeletal system, dose-effect models derived from empirical studies and more detailed analyses of the actual operating scenarios are required, to be obtained for example by three-dimensional force measurements.

8.2.3 Recommendations for the spatial location of controls

As has been shown by studies in the field and in particular by inspections of various modern agricultural machines, anthropometric data are not adequately considered in the design of agricultural machinery.

In order to permit ergonomic design of the work equipment, greater attention must be paid to the reachability of the manually operated parts. For agricultural machinery to have a broad user base, manually operated parts should not lie outside the reach of the 5th percentile woman. The authors recommend that references to standards relevant to this aspect be incorporated into the agricultural machinery standards. Reference is made by way of example in this context to the German DIN 33402-2 standard [29] and the international CEN ISO/TR 7250-2 technical report [30]. The ranges outside the reach are highlighted in grey in the tables of guideline values contained in Annex 6.

8.2.4 Recommendations for designers of agricultural machinery

As a general rule, the authors recommend that the operating forces on manually operated parts be kept as low as possible (for example by favourable lever design, the use of suitable gas springs and hydraulic cylinders, or by electric drives), and that the manually operated parts be made easily accessible. Differences in body height should be considered. The height of upward-opening side flaps on combine harvesters is for example a common problem. In the open position, these flaps are frequently so high that smaller operators can barely reach them. At the same time, it is often also desirable for the flaps to open as wide as they do in order to facilitate adjustments and maintenance of the machinery. A certain stiffness of flap movement is also desirable, in order to prevent them from being blown shut by strong winds. A lower flap height placing the edge of the open flap at the head height of taller operators has the drawback of presenting a risk of injury. This dilemma could for example be resolved by flaps opening wide upwards being fitted with straps or cords with handles that can be reached from lower heights. In the case of manually operated parts such as levers, the required operating force can be reduced by a longer lever arm or a more favourable ratio (with a greater operating distance). The guidance document concerning the key indicator method for manual working processes contains design information on this topic. For optimum transmission and application of force, it is important that the manually operated parts facilitate being gripped (ergonomic handles). Clench grips with the entire hand enable

high action forces to be applied. Positive force application is better than non-positive force application [32]. Handles without adapted geometry (too thin or short) should generally be avoided (see Fig. 74 and Fig. 75).



Fig. 74: *Lever with handle that is too thin, thus impeding force transmission*

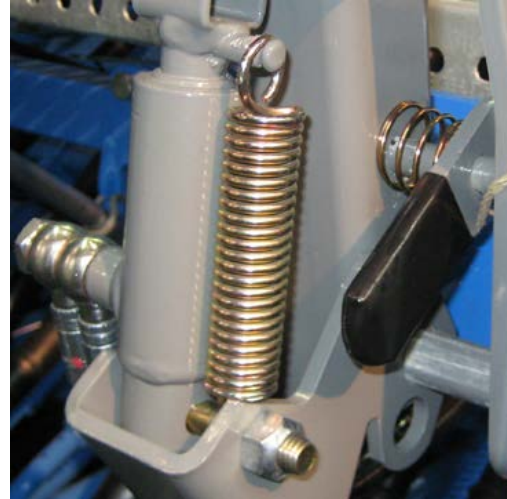

Fig. 75: *Lever with handle that is too short, thus impeding force transmission*

8.2.5 Recommendations for the Ergonomics standards committee

The present study trialled two measurement methods; the simple method is recommended for use in the field. The authors suggest that the Ergonomics standards committee formulate this method in a standard.

In order to assist in the formulation of test requirements, the authors recommend that the standard be based upon the points described in Section 5.1 and the recommendations made in this chapter. Alternatively, the standard could be based upon the checklist, drawn up concurrently by KAN, for "Assistance in the formulation of test requirements involving measurements" [33]. Based upon this checklist, Table 10 summarizes the most important factors influencing a measurement method, and their parameters. Where the present report contains passages addressing/discussing these parameters, the table also includes references to them.

The measurement of isometric maximum forces should also be generally standardized. This could be combined with a supplementary amendment to the existing EN 1005-3 standard [2] incorporating the determination of isometric maximum forces, including the spatial arrangement of the manually operated part (point of force application) and the body postures to be assumed for this purpose.

Table 10: Influencing factors and their parameters for the formulation of test requirements involving measurements [33]

Influencing factor	Parameters	Reference to section
1. Item under test	Condition of the item under test Items under test: new or used? Definition of prior treatment, conditioning and state of maintenance of the item under test	5.1.5 8.2.1
2. Test arrangement	Measurement equipment The properties of the measurement equipment and if applicable the validation methods must be specified. The measurement point and the position and means of attachment of the sensors must also be defined.	5.1.1 8.1.1 8.2.1
	Further components of the test arrangement Further components required for performance of the test, and their properties	5.1.2 5.1.4 5.1.5 7.1
	Condition of the test equipment Prior treatment and conditioning of the test equipment	5.1.2 8.2.1
	Ambient conditions Specification of the climatic conditions and of the location and spatial arrangements for testing	5.1.2 8.2.1
	Arrangement of the item under test Description and dimensions of the test arrangement; position/posture of the test subject	5.1.2 5.1.3 5.1.4 8.2.1
3. Performance of testing	Test procedure Specification of the test sequence, time intervals, number of repetitions	5.1.2 8.2.1
	Conditions of use/conditions of operation for the item under test Specification of whether testing is to be performed under field conditions or substitute conditions	8.2.1
	Number of items to be tested	Not specified
4. Test subject	Experience, anthropometrics Familiarity with the test method and with the minimum and maximum requirements for the anthropometrics of the test subject(s)	8.1.1 8.2.1
5. Evaluation	Method of calculation Definition of the method of calculation for the correction or interpretation of the test results. Also: definition of the result	5.1.2 5.1.3 5.1.6 5.1.7 8.2.1

8.2.6 Recommendations for the Agricultural Machinery standards committee and the VDMA

The generic force values stated in agricultural standards (400 N, 250 N, 200 N) are not tenable. The spatial arrangement of the manually operated part must be taken into account in the definition of maximum operating forces. With particular consideration for the fact that agricultural machinery is also operated by women, considerably lower maximum force values must be defined in standards, as a function of the location of the manually operated part. Agricultural machinery standards should contain provisions on the reachability of manually operated parts, in addition to the maximum operating forces. Manually operated parts should not lie outside the reach of the 5th percentile woman. A reference to the German DIN 33402-2 standard [29]/international CEN ISO/TR 7250-2 technical report [30] would be advantageous.

The authors recommend that trials be commissioned, for example by the German Engineering Federation (Verband Deutscher Maschinen- und Anlagenbau e.V., VDMA) through its member companies (agricultural machinery manufacturers), of the approach proposed here, the measurement of operating forces by means of the proposed method and the comparison of the results with the guideline maximum force values stated in the tables. Manufacturers of other machinery (such as construction machinery) could also be contacted regarding trialling of the methods for application to these manufacturers' machines. Should these tables be found practicable, they should be further validated by supplementary measurements and could then be incorporated into a dedicated standard to which reference could then be made, for example in the standards governing agricultural machinery.

8.2.7 Recommendations for the BMBF and the BMAS

The measurements conducted to date of operating forces on agricultural machinery should be extended with the addition of further operating scenarios conducted by experienced users of agricultural machinery under conditions resembling those encountered in practice. The authors also recommend that further measurements of operating forces be performed on further machine types (such as construction machinery, forestry vehicles, etc.), again with the involvement of experienced machine users.

The tables of guideline maximum forces should be further validated with a larger test collective and extended by further force scenarios (location of manually operated parts, different anthropometrics). Reduction factors must be calculated for operating scenarios that occur frequently. No sufficiently robust information on validity is available for the force evaluation methods that exist for this purpose, such as those in EN 1005-3 or for example the Siemens Burandt method and its derivatives. Such a method could be validated jointly in a more comprehensive survey to be conducted within a basic research project by the German Federal Ministry of Education and Research (BMBF) or the German Federal Ministry of Labour and Social Affairs (BMAS).

9. Literature

- [1] Gramatte, W.: Safety of agricultural machinery, KAN Report 41, Verein zur Förderung der Arbeitssicherheit in Europa e.V. (eds.), 2008.
- [2] EN 1005: Safety of machinery – Human physical performance Part 3: Recommended force limits for machinery operation, Beuth Verlag, Berlin, 2009.
- [3] Wakula, J.; Berg, K.; Schaub, K.; Bruder, R.; Glitsch, U.; Ellegast, R.: Der montagespezifische Kraftatlas, BGIA-Report 3/2009, Deutsche Gesetzliche Unfallversicherung (eds.), 2009.
- [4] Riedel, S.; Adler, S.; Gillmeister, F.; Köckritz, S.; Mussnug, J.; Mutschler, H.; Pencz, E.; Schenk, T.: Measurement requirements in product standards, KAN Report 46, Verein zur Förderung der Arbeitssicherheit in Europa e.V. (eds.), 2010.
- [5] Kirchner, J.H.: Arbeitswissenschaftlicher Beitrag zur Automatisierung – Analyse und Synthese von Arbeitssystemen. Schriftenreihe Arbeitswissenschaft und Praxis. Beuth, Berlin, 1972.
- [6] Rohmert, W.: Formen menschlicher Arbeit. In: Rohmert W., Rutenfranz J. (eds.), Praktische Arbeitsphysiologie. Georg Thieme Verlag, Stuttgart, New York, 1983.
- [7] Laurig, W.: Grundzüge der Ergonomie. REFA Fachbuchreihe Betriebsorganisation. 3rd edition, Beuth Verlag, Berlin, 1990.
- [8] DIN 33411, Part 1: Körperkräfte des Menschen; Begriffe, Zusammenhänge, Bestimmungsgrößen. Beuth Verlag, Berlin, 1982.
- [9] KROEMER, K.H.E.: Die Messung der Muskelstärke des Menschen. Forschungsbericht der Bundesanstalt für Arbeitsschutz und Arbeitsmedizin. Forschungsbericht Nr. 161. Dortmund, 1977.
- [10] Hettinger, Th.: Isometrisches Muskeltraining. 5th edition. Georg Thieme Verlag, Stuttgart/New York 1983.
- [11] Hollmann, W.; Hettinger, Th.: Sportmedizin – Arbeits- und Trainingsgrundlagen. 3rd edition. Schattauer, Stuttgart/New York 1990.
- [12] Rohmert, W.; Hettinger, Th.: Körperkräfte im Bewegungsraum. RKW Reihe Arbeitsphysiologie – Arbeitspsychologie. Beuth; Berlin, Cologne, 1963.
- [13] Mainzer, J.: Ermittlung und Normung von Körperkräften – dargestellt am Beispiel der statischen Betätigung von Handrädern. VDI-Verlag, Düsseldorf 1982.
- [14] Kroemer, K.H.E.: Assessment of human muscle strength for engineering purposes: a review of the basics. Ergonomics, 1999, Vol. 42, No 1, pp. 74-93.
- [15] Kroemer, K.H.E.; Kroemer, H.J.; Kroemer-Elbert, K.E.: Engineering Physiology. 4th Edition. Springer, Heidelberg – New York – London, 2010.

-
- [16] Rohmert, W.; Jenik, P.: Maximalkräfte von Frauen im Bewegungsraum der Arme und Beine. Beuth, Berlin/Cologne/Frankfurt 1972.
- [17] Rohmert, W.; Rückert, A.; Schaub, K.: Körperkräfte des Menschen. Selbstverlag des Institutes für Arbeitswissenschaft an der Technischen Hochschule Darmstadt (eds.), 1992.
- [18] Rohmert, W.; Berg, K.; Bruder, R.; Schaub, K.: Kräfteatlas, Part 1: Datenauswertung statischer Aktionskräfte. 1st edition. Publications of the Bundesanstalt für Arbeitsschutz und Arbeitsmedizin: research report, Fb 09.004. Berlin, 1994.
- [19] Rohmert, W.; Berg, K.; Bruder, R.; Schaub, K.: Kräfteatlas, Part 2: Literaturzusammenstellung. 1st edition. Publications of the Bundesanstalt für Arbeitsschutz und Arbeitsmedizin: Fb 09.004. Berlin 1994.
- [20] Rühmann, H.; Schmidtke, H.: Körperkräfte des Menschen – Perzentilisierung isometrischer Maximalkräfte sowie Ausdauer und Beanspruchung bei konzentrischer und exzentrischer Muskelarbeit. O. Schmidt, Cologne 1992.
- [21] Caldwell, L.S.; Chaffin, D.B.; Dukes-Dobos, F.N.; Kroemer, K.H.; Laubach, L.L.; Snook, S.H.; Wasserman, D.E.: A proposed standard procedure for static muscle strength testing. Am Ind Hyg Assoc J. 1974 Apr; 35(4): pp. 201-206.
- [22] Klußmann, A. et al.: ASER Handmaß- und Kraftdatenbank. Publications of Institut ASER e.V., research report, in preparation.
- [23] NPR 2739 Menselijke fysieke belasting – Kenmerken en meetmethoden.
- [24] NF X 35-109 Manutention manuelle de charge pour soulever, déplacer et pousser/tirer – méthodologie d'analyse et valeurs seuils.
- [25] Steinberg, U.; Windberg, H.-J.: Heben und Tragen ohne Schaden. 6th edition. BAuA brochure. Dortmund, 2011.
- [26] Steinberg, U.; Caffier, G.; Liebers, F.; Behrendt, S.: Ziehen und Schieben ohne Schaden. BAuA brochure. 4th edition. Dortmund, 2008.
- [27] ISO 11228, Part 1: Ergonomics – Manual handling – Lifting and carrying. 2003.
- [28] ISO 11228, Part 2: Ergonomics – Manual handling – Pushing and pulling. 2007.
- [29] DIN 33402, Part 2: Ergonomics – Human body dimensions – Part 2: Values Beuth Verlag, Berlin, 2005.
- [30] CEN ISO/TR 7250, Part 2: Basic human body measurements for technological design – Statistical summaries of body measurements from individual ISO populations, Beuth, Berlin, 2011.
- [31] ISO 5725, Part 2: Accuracy (trueness and precision) of measurement methods and results – Basic method for the determination of repeatability and reproducibility of a standard measurement method, Beuth, Berlin, 2002.

- [32] Steinberg, U.; Liebers, F.; Klußmann, A.: Manuelle Arbeit ohne Schaden. Revised version 2013. BAuA brochure. Dortmund, 2013.
- [33] KAN: Assistance in the formulation of test requirements involving measurements: Draft by the Kommission für Arbeitsschutz und Normung, as at 2011-04-19. www.kan.de/fileadmin/Redaktion/Dokumente/Sonstige/en/Assistance_test_requirements.pdf

10. Annexes

Annex 1: Overview of the standards analysed

Document number	Title/key words	Title
EN 81-3 2011-06	Lifts	Safety rules for the construction and installation of lifts – Part 3: Electric and hydraulic service lifts
EN 81-31 2010-08	Lifts	Safety rules for the construction and installation of lifts – Lifts for the transport of goods only – Part 31: Accessible goods only lifts
EN 12158-1 2011-06	Builders' hoists	Builders' hoists for goods – Part 1: Hoists with accessible platforms
ISO 11228-1: 2003	Ergonomics	Ergonomics – Manual handling – Part 1: Lifting and carrying
ISO 11228-2: 2007	Ergonomics	Ergonomics – Manual handling – Part 2: Pushing and pulling
DIN 33402-2: 2005	Ergonomics	Human body dimensions – Part 2: Values
CEN ISO/ TR 7250-2: 2011	Ergonomics	Basic human body measurements for technological design – Part 2: Statistical summaries of body measurements from national populations
EN 12643 2010-04	Earth moving machinery	Earth moving machinery – Rubber-tyred machines – Steering requirements
EN 861 2010-02	Woodworking machines	Safety of woodworking machines – Surface planing and thicknessing machines
EN 1493 2011-02	Lifts	Vehicle lifts
EN 1494 2009-05	Lifts	Mobile or movable jacks and associated lifting equipment
EN 1570 2009-12	Lifts	Safety requirements for lifting tables
EN 1756-1 2008-10	Lifts	Tail lifts – Platform lifts for mounting on wheeled vehicles – Safety requirements – Part 1: Tail lifts for goods
EN 1756-2 2009-12	Lifts	Tail lifts – Platform lifts for mounting on wheeled vehicles – Safety requirements – Part 2: Tail lifts for passengers
EN 1808 2010-11	Lifts	Safety requirements on Suspended Access Equipment – Design calculations, stability criteria, construction – Tests
EN 12570 2000-10	Industrial valves	Industrial valves – Method for sizing the operating element
EN 13140 2010-09	Agricultural machinery	Agricultural machinery – Sugar beet and fodder beet harvesting equipment – Safety
prDIN EN 16246 2011-3	Agricultural machinery	Agricultural machinery – Backhoes – Safety
EN 632	Agricultural machinery	Agricultural machinery – Combine

1995-08		harvesters and forage harvesters – Safety
EN 707 2009-12	Agricultural machinery	Agricultural machinery – Slurry tankers – Safety
EN 745 2010-01	Agricultural machinery	Agricultural machinery – Rotary mowers and flail-mowers – Safety
EN 907 1997-07	Agricultural machinery	Agricultural and forestry machinery – Sprayers and liquid fertilizer distributors – Safety
EN ISO 4254-1 2011-05	Agricultural machinery	Agricultural machinery – Safety – Part 1: General requirements
EN ISO 4254-6 2011-10	Agricultural machinery	Agricultural machinery – Safety – Part 6: Sprayers and liquid fertilizer distributors
EN ISO 4254-7 2011-05	Agricultural machinery	Agricultural machinery – Safety – Part 7: Combine harvesters, forage harvesters and cotton harvesters
EN ISO 4254-10 2011-07	Agricultural machinery	Agricultural machinery – Safety – Part 10: Rotary tredders and rakes
EN 13561 2011-06	External blinds	External blinds and awnings – Performance requirements including safety
DIN 5566-1 2006-09	Railway vehicles	Railway vehicles – Driver cabs – Part 1: General requirements
EN 1005-2 2009-05	Safety of machinery	Safety of machinery – Human physical performance – Part 2: Manual handling of machinery and component parts of machinery
EN 1005-3 2009-01	Safety of machinery	Safety of machinery – Human physical performance – Part 3: Recommended force limits for machinery operation
EN 614-1 2009-06	Safety of machinery	Safety of machinery – Ergonomic design principles – Part 1: Terminology and general principles

Annex 2: Passages concerning operating forces in standards

The table below lists the standards, a key word relating to the title, the relevant section, and the relevant passages containing provisions governing operating forces. The list is sorted according to the title/key word.

Standard	Title/key words	Section	Text
EN 81-3: 2011-06	Lifts	0.3.9	For horizontal forces, the following have been used: a) static force: 300 N b) force resulting from impact: 1000 N ; reflecting the values that one person can exert.
EN 81-3: 2011-06	Lifts	12.2.4.1	If the manual effort required to move the car in the upward direction with its rated load does not exceed 400 N the machine shall be provided with a manual means of emergency operation allowing the car to be moved to a landing with the aid of a smooth, spokeless wheel.
EN 81-31: 2010-08	Lifts	0.3.9	For horizontal forces, the following have been used: a) static force: 300 N b) force resulting from impact: 1000 N ; reflecting the values that one person can exert.
EN 81-31: 2010-08	Lifts	5.2.11. 2.3.1	If the effort required to position the mechanical means exceeds 200 N or the lower effort applicable according to EN 1005-3 , its actuation has to be powered;
EN 81-31: 2010-08	Lifts	G.1.5	Where means are provided to manually operate the lift in order to bring the load carrying unit to a landing, the following requirements apply: a) the manual effort required to move the load carrying unit in the upward direction with its rated load shall not exceed 400 N ; ...
EN 12158-1: 2011-06	Builders' hoists	5.5.3.1.6	... The maximum distance between the closed landing gate and any handle provided on the platform to close any horizontal clearance, shall not exceed 0,6 m. The force required to operate this handle shall not exceed 150 N horizontally even under the least favourable in service wind condition.
EN 12643: 2010-04	Earth moving machinery	10.4.3	... the steering effort shall not exceed 115 N .
EN 12643: 2010-04	Earth moving machinery	10.4.4	Steering effort shall not exceed 350 N ...
EN 861: 2010-02	Woodworking machines	5.4.5	The maximum force necessary for the raising or tilting of the surface planing table to set the machine for thickening shall be 300 N .
EN 1493: 2011-02	Lifts	5.16.5	The manual forces at an ambient temperature of (20 ± 5) °C shall not exceed 400 N to start the movement and 300 N to sustain the movement on a flat level floor.

EN 1493: 2011-02	Lifts	5.20	... The driving force on the provided handle measured at the end of it at the rated load at an ambient temperature of (20 ± 5) °C shall not exceed 400 N when driven according to the manufacturer's specification.
EN 1494: 2009-05	Lifts	C.1	The maximum manual forces required for jack operations (unloaded respectively loaded with rated load) shall not exceed the following figures: ...
EN 1570: 2009-12	Lifts	5.6.11	The maximum manual forces required from one person to move a mobile lifting table without load shall not exceed 300 N to start the movement and 200 N to sustain the movement. (See Annex F for force measurement methods.)
EN 1570: 2009-12	Lifts	5.8.11	When a hand pump is used to operate the lifting table, the operating force on the handle provided, measured at the end of the handle when raising the rated load, shall not exceed 200 N when operating according to the manufacturer's instructions. This figure (200 N) may be increased to 300 N for foot pumps. (See Annex F for measurement methods.)
EN 1570: 2009-12	Lifts	F.1	The maximum manual forces required for mobile lifting table operations shall not exceed the following figures: ...
EN 1756-1: 2008-10	Lifts	5.3	Manual effort shall not exceed 250 N in accordance with the requirements of EN 1005-3. However, to initiate motion, the effort shall not exceed 350 N.
EN 1756-2: 2009-12	Lifts	5.3	In the case of passenger-operated tail lifts, the manual effort required to operate the lift shall not exceed 50 N and the manual effort for finger activation of controls shall not exceed 5 N (see clause 6). In other cases, the manual effort required to operate the tail lift shall not exceed 200 N . However, to initiate motion, the effort shall not exceed 250 N .
EN 1808: 2010-11	Lifts	8.2.2.2	The maximum force applied to the end of the crank(s) for lifting the WLL of the hoist shall not exceed 250 N .
EN 1808: 2010-11	Lifts	8.2.3.2	The maximum force applied to the end of the lever for lifting the WLL of the hoist shall not exceed 400 N .
EN 1808: 2010-11	Lifts	9.1.3	The maximum force applied to the end of the cranks in operation shall not exceed 250 N .
EN 1808: 2010-11	Lifts	9.2.3.4	Rotating davits shall be designed to allow rotation with a manual force not exceeding 250 N .
EN 1808: 2010-11	Lifts	9.2.3.5.1	To ensure that the user is not required to apply an effort of more than 250 N to rig and transport the jib, consideration shall be given to the self-weight and size of the individual components forming part of the davit system.
EN 1808: 2010-11	Lifts	9.2.3.5.2	Davits which require a physical effort in excess of 250 N to relocate them shall be fitted with wheels to reduce the effort to or below

			250 N.
EN 1808: 2010-11	Lifts	B.2.1	A manual hoist shall lift or lower the WLL with a force, applied to the end of the crank or lever, not exceeding 250 N or 400 N respectively.
EN 12570: 2000-10	Industrial valves	5.1	The value of the operating manual force F and the maximum manual force F_s used to calculate the size of the operating element according to 5.2 shall be as given in Table 1. ...
EN 13140: 2010-09	Agricultural machinery	4.4.3.2	... The change from the working position to the transport position and vice versa shall occur without causing a crushing or pinching hazard. The movement of the folding elements shall be powered if the manual force needed for the manoeuvre exceeds 250 N.
prDIN EN 16246: 2011-3	Agricultural machinery		The operating force required for moving parts of the boarding means shall not exceed 200 N at the point intended for manipulation by the operator according to the manufacturer's design and specification.
EN 632: 1995-08	Agricultural machinery	5.2	Controls requiring an actuating force $\geq 100 \text{ N}$ measured at the grip shall have a minimum clearance of $a = 50 \text{ mm}$ between the outer contours. Controls requiring an actuating force of $< 100 \text{ N}$ shall have a minimum clearance of $a = 25 \text{ mm}$ (see figure 1). Fingertip controls are excluded from the above requirements, providing there is no risk of inadvertent operation of adjacent controls.
EN 632: 1995-08	Agricultural machinery	5.3.4	... The operating force shall not exceed 200 N.
EN 707: 2009-12	Agricultural machinery	4.2.3.1	The folding/unfolding operations shall not require a manual force greater than 250 N.
EN 707: 2009-12	Agricultural machinery	4.2.3.2	The manual force necessary to adjust the height of the boom shall not exceed 250 N.
EN 745: 2010-01	Agricultural machinery	4.4	... The change from the working position to the transport position and vice versa shall occur without causing a crushing or pinching hazard. The movement of the folding elements shall be powered if the manual force needed for the manoeuvre exceeds 250 N.
EN 907: 1997-07	Agricultural machinery	4.4.4	The manual force necessary to adjust the height of the boom shall not exceed 250 N. ...
EN ISO 4254 -1:2011-05	Agricultural machinery	4.4.3	Hand-operated controls requiring an actuating force $\geq 100 \text{ N}$ shall have a minimum clearance , a , of 50 mm between the outer contours or from adjacent parts of the machine (see Figure 2). Controls requiring an actuating force $< 100 \text{ N}$ shall have a minimum clearance of 25 mm . This requirement does not apply to fingertip operation controls, e.g. push-buttons, electric switches.

EN ISO 4254-1:2011-05	Agricultural machinery	4.4.5	Handle(s) located at least 300 mm from the nearest articulation shall be provided for manually folded elements. The handle(s) can be integral parts of the machine provided they are suitably designed and clearly identified. The force required for the manual folding operation shall not exceed 250 N as an average value when moving from the start to the stop position. The peak(s) shall not exceed 400 N . There shall be no shearing, pinching or uncontrollable movement hazards to the operator when folded.
EN ISO 4254-1:2011-05	Agricultural machinery	4.5.1.2.4	If parts of the boarding means are moveable, the operating force shall not exceed 200 N as the average value when moving from the start to the stop position. The peak(s) shall not exceed 400 N .
EN ISO 4254-10:2011-07	Agricultural machinery	5.6	... The movement of foldable components shall be assisted when the required manual actuating force exceeds 250 N .
EN ISO 4254-6:2010-11	Agricultural machinery	5.3.3	The manual force necessary to adjust the height of the boom shall not exceed 250 N .
EN ISO 4254-7:2011-05	Agricultural machinery	5.2.2	Controls requiring an actuating force ≥ 100 N measured at the grip shall have a minimum clearance, a, of 50 mm between their outer contours and adjacent parts. Controls requiring an actuating force of < 100 N shall have a minimum clearance, a, of 25 mm...
EN ISO 4254-7:2011-05	Agricultural machinery	5.5.3	Handle(s), located at least 300 mm from the nearest articulation, shall be provided for manually folded elements. The force required for the manual folding operation shall not exceed 250 N as the average value when moving from the start to the stop position. The peak(s) shall not exceed 400 N .
EN ISO 4254-7:2011-05	Agricultural machinery	6.4.1.3	The grain tank shall be designed so that the need to enter the grain tank (e.g. raising extensions, opening covers, raising the grain tank filling auger) is minimized. Where possible, these actions shall be possible from outside the grain tank. If parts or components have to be raised or lowered manually, the required force shall not exceed 400 N .
EN 13561:2011-06	External blinds	7.3.1	Operating effort F_c shall not exceed the values in Table 3.
EN 13561:2011-06	External blinds	7.3.2	The maximum values for F_c are given in Table 4.
DIN 5566-1:2006-09	Railway vehicles	5.6	Die Seitenfenster müssen leicht zu öffnen sein. Die maximale Bedienkraft darf 50 N auch nach längerem Einsatz nicht überschreiten. (<i>The side windows shall be easy to open. The maximum operating force shall not exceed 50 N even after longer use.</i>)
EN 1005-2:2009-05	Safety of machinery	A.1	Table A.1 "Population percentages in relation to measurement criteria and the object mass" (the table presented here applies to the general working population. This information is in

			accordance with measurements of maximum energetic capacity, subjective estimation of tolerability limits and objective measurements of physical capabilities.)
EN 1005-3: 2009-01	Safety of machinery	4.2.1	Table 1 "Maximal isometric force" (Pre-calculated isometric force limits for some common activity for professional and domestic use. The values apply to optimal working conditions.)
EN 614-1: 2009-06	Safety of machinery	4.3.5	<p>Physical strength: Actions during machinery operation which requires the application of high force can cause strain to the musculo-skeletal system. Unfavourable musculo-skeletal strain increases the risk of fatigue, discomfort and musculo-skeletal disorders.</p> <p>a) mechanical aids shall be provided, where the necessary physical force to be applied cannot be kept to a safe level;</p> <p>b) prolonged static muscle tension (such as caused by arms and hands being held or lifted) shall be avoided. The weight of hand-held equipment may be an important cause of muscle fatigue when prolonged periods of use are required and its effects should be reduced, e.g. by supporting the equipment on a suspension system;</p> <p>c) the application of physical force shall be minimised wherever possible by utilising measures such as balance weights;</p> <p>d) control actuators, grips, handles and pedals of machinery shall be designed, selected and arranged to meet the requirements of EN 894-3;</p> <p>e) depending on the force demands, size, shape and position of control actuators, uneven loading of the body and limbs shall be avoided;</p> <p>f) the weight distribution of hand held and portable equipment shall ensure proper balance in relation to their handles and support areas.</p> <p>NOTE: EN 1005-2 and EN 1005-3 describe how the designer of machinery can keep the required forces to acceptable levels...</p>

Annex 3: Trialling of operating scenarios in the field

Presentation of the practical trials on agricultural machinery supplementing Section 5.2.

10.1.1 Operation of levers

10.1.1.1 Measurement by means of a hand-held force meter: opening of a grain tank



Fig. 76 and Fig. 77: Opening of a grain tank on a combine harvester (Claas Mega 350). Half a turn is required to open the tank. Measurement by means of a hand-held force meter. Left: test subject 1; right: test subject 2

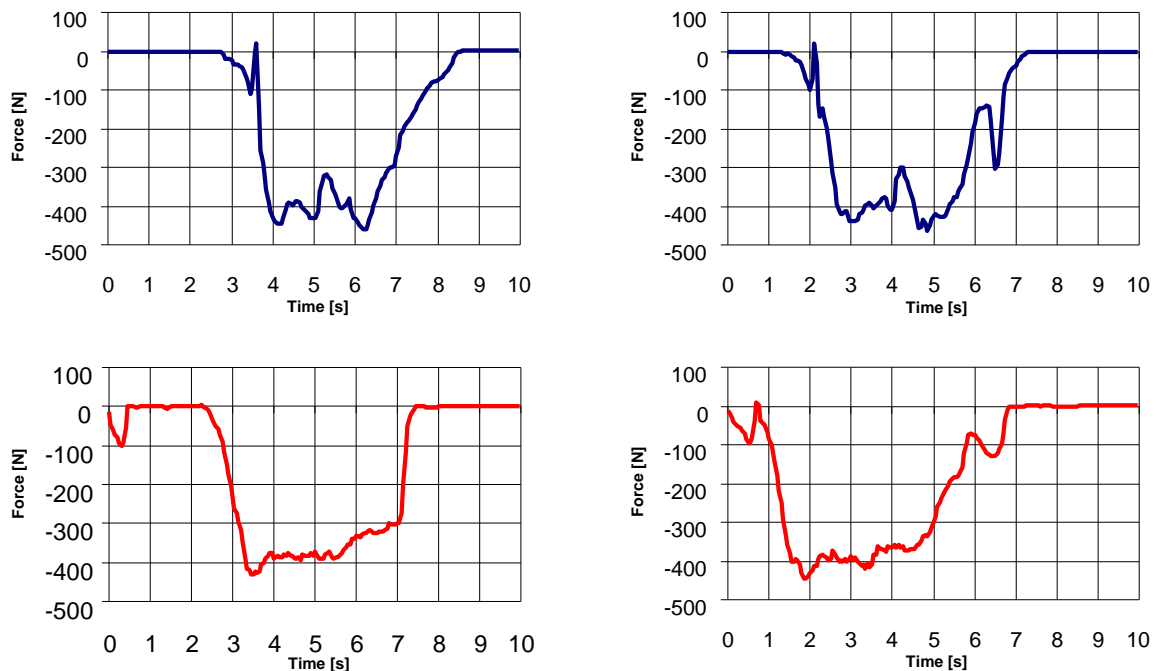

Fig. 78: Force/time diagrams for the opening of the grain tank. Measurement by means of a hand-held force meter. Top (blue): test subject 1; bottom (red): test subject 2

10.1.1.2 Measurement by means of a hand-held force meter: operation of a lever for adjustment of a chopper on a combine harvester

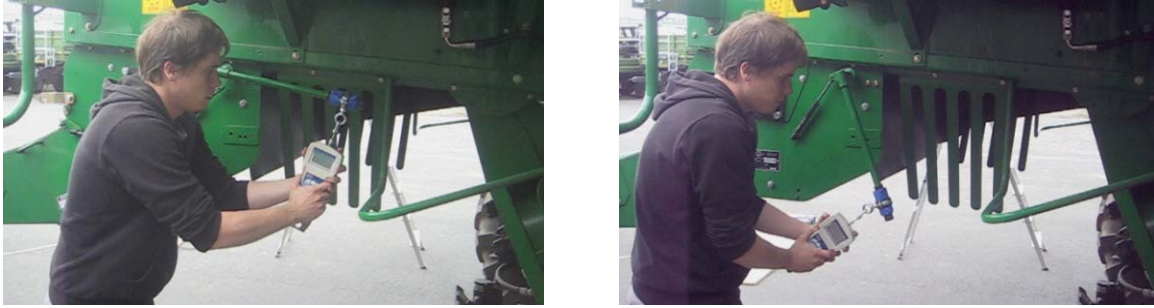

Fig. 79 and Fig. 80: Lever for adjustment of the chopper on a combine harvester (John Deere T560). Measurement of the pulling force by means of a hand-held force meter; force transmission by means of a hose clip; test subject 2

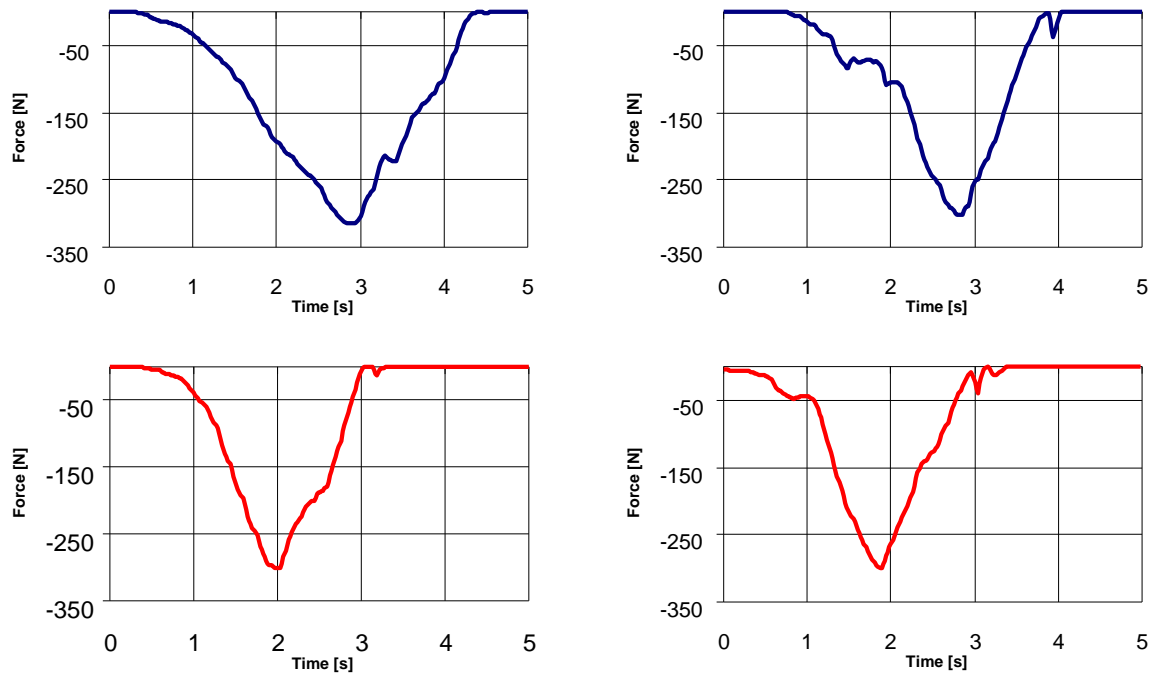

Fig. 81: Force/time diagrams of actuation of the lever for adjustment of the chopper, measurement of the pulling force by means of a hand-held force meter; forces up to a peak of 300 N had to be exerted. Graphs top (blue): test subject 3; graphs bottom (red): test subject 2

10.1.1.3 Measurement by means of a hand-held force meter: operation of a lever on the inclined conveyor of a combine harvester



Fig. 82 and Fig. 83: Lever on the inclined conveyor of a combine harvester (John Deere T560). Measurement of the pulling force by means of a hand-held force meter; force transmission by means of a hose clip; test subject 2

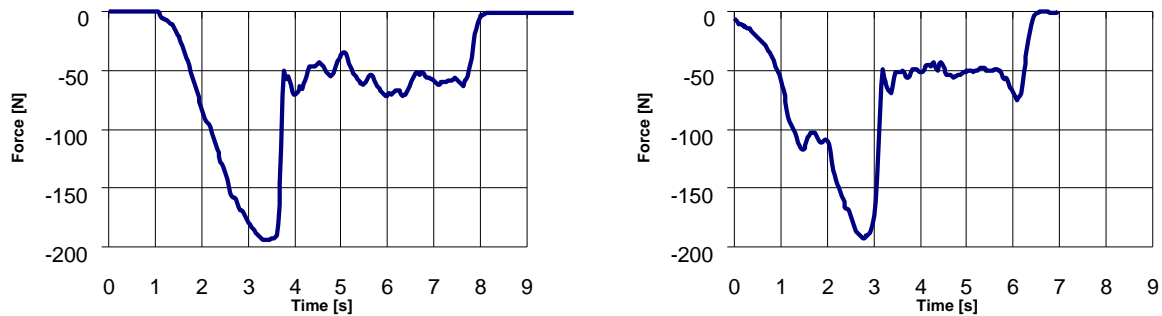

Fig. 84: Force/time diagrams of actuation of a lever on the inclined conveyor, measurement of the pulling force by means of a hand-held force meter; test subject 2. The measurements performed return similar results

The results of the measurements considered here during the operation of levers on agricultural machinery are summarized in Table 11.

Table 11: Overview of the force measurements on levers

Item under test	Measurement method	Repeats	F_{\max} [N] (mean)	F_{\max} [N] (min)	F_{\max} [N] (max)
Opening of a grain tank TS1	Hand-held force meter	4	468	450	500
Opening of a grain tank TS2	Hand-held force meter	3	440	430	450
Chopper adjustment TS2	Hand-held force meter	3	305	300	310
Chopper adjustment TS3	Hand-held force meter	3	308	300	320
Lever on inclined conveyor TS1	Hand-held force meter	2	194	193	194

* Note: the measurements in the table are guideline values only. The purpose of these measurements was to test the usability of the measurement method. Differences between measurements on the same item under test may be attributable to the absence of a defined final position of the movement. The repetitiveness of measurements was determined in the laboratory, and is described in Section 5.3.

10.1.2 Swivelling of flaps/covers/shrouds/components

10.1.2.1 Measurement by means of a hand-held force meter:

Opening of a rear flap



Fig. 85 and Fig. 86: Opening of a rear flap on a combine harvester (Claas Mega 350), measurement with hand-held force meter, test subject 2

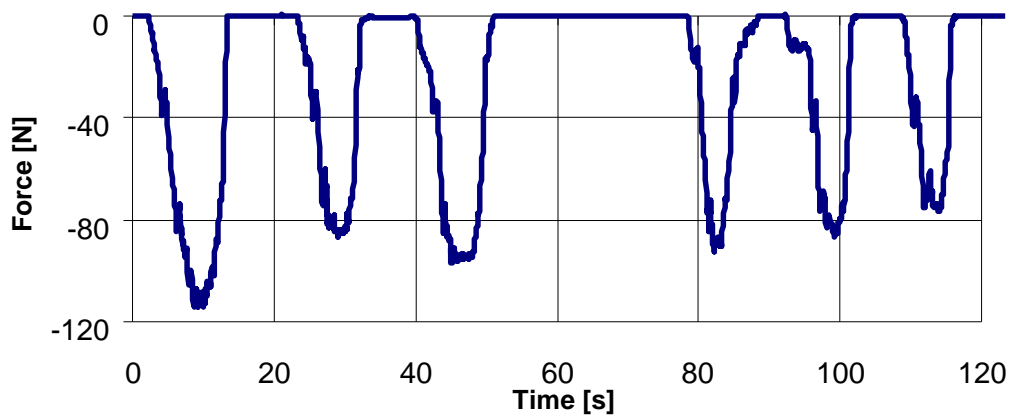

Fig. 87: Force/time diagram of opening of the rear flap on a combine harvester: measurement with a hand-held force meter, test subject 2. The maximum force attained in each measurement is dependent upon the opening angle of the rear flap; the different test subjects do not necessarily reach the same height when opening the flap

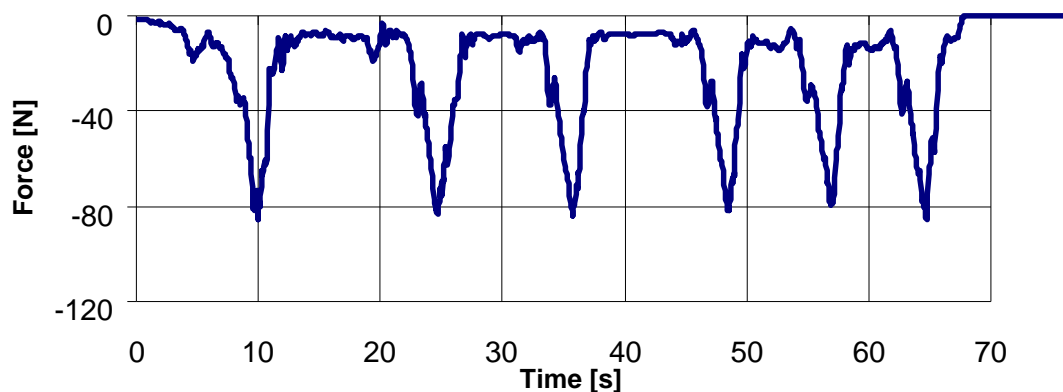

Fig. 88: Force/time diagram of opening of the rear flap on a combine harvester: measurement with a hand-held force meter, test subject 3. The maximum attainable force is dependent upon the opening angle of the rear flap and thus upon the height of the test subject

10.1.2.2 Measurement of pulling force by means of a hand-held force meter: Closing of the side flap on a round baler



Fig. 89 and Fig. 90: Closing of the side flap on a round baler (Kuhn VB 2190): measurement of the pulling force by means of a hand-held force meter, force transmission via a draw hook on a metal strut, test subject 3. Below an opening angle of approximately 30°, the force of the gas spring is overcome and the flap drops into the engagement mechanism of its own accord

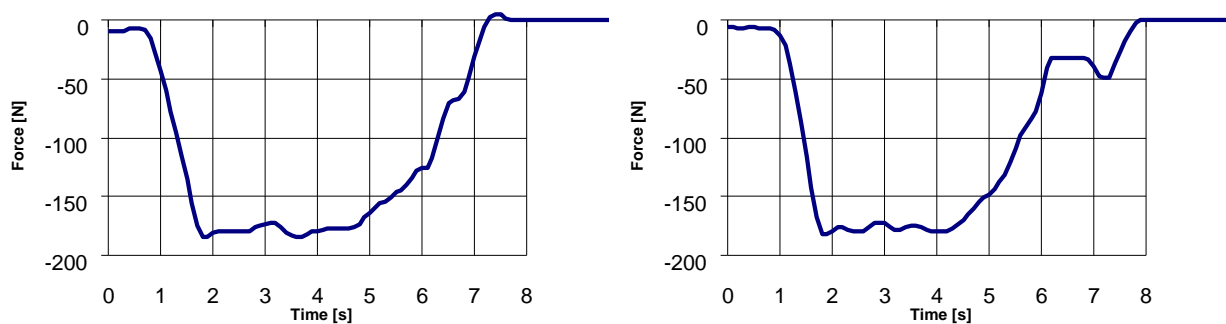

Fig. 91: Force/time diagrams of closing of the side flap, pulling force measurement by means of a hand-held force meter. Test subject 3. The repeats of the measurements performed return similar results

10.1.2.3 Measurement by means of a hand-held force meter: Closing of the side flap (left) of a combine harvester



Fig. 92 and Fig. 93: Closing of the left-hand side flap on a combine harvester (John Deere T560): measurement of the pushing force by means of a hand-held force meter, force transmission through a plastic mat to prevent damage to the surface, test subject 2

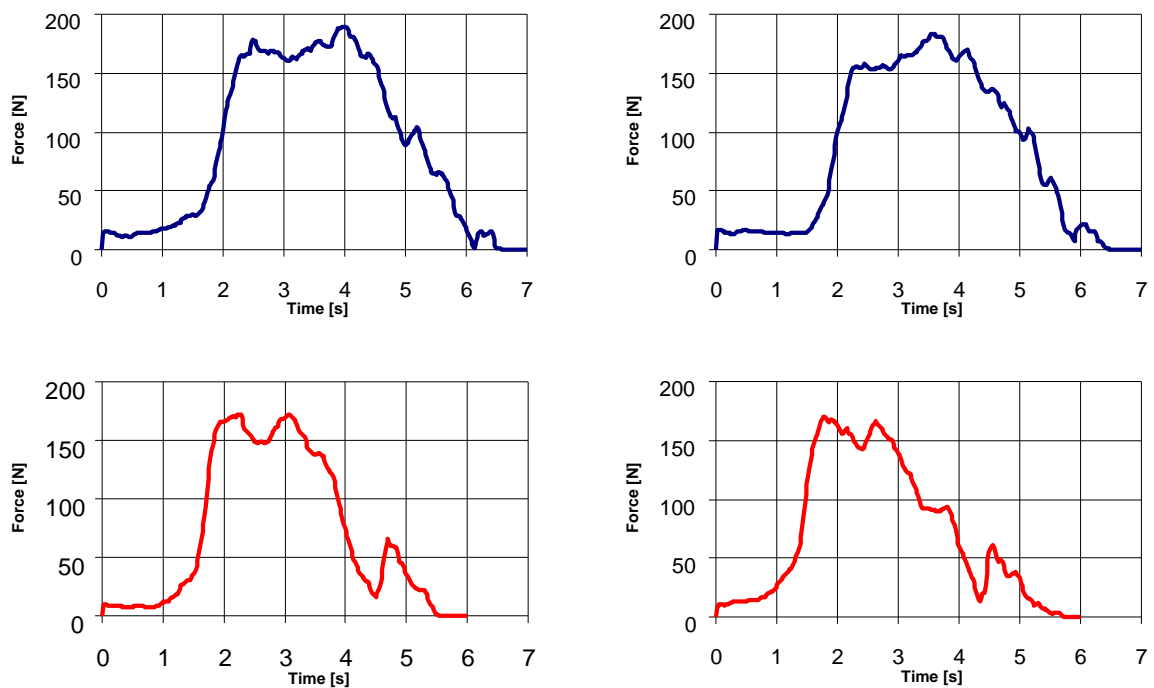

Fig. 94: Force/time diagrams of closing of the left-hand side flap, measurement of the pushing force by means of a hand-held force meter. The measurements return similar results when performed by different test subjects. Graphs top (blue): test subject 4; graphs bottom (red): test subject 2

10.1.2.4 Measurement by means of the complex method:
Closing of the side flap (left) of a combine harvester



Fig. 95: Closing of the left-hand side flap on a combine harvester (John Deere T560): measurement of the pulling force by means of the complex method

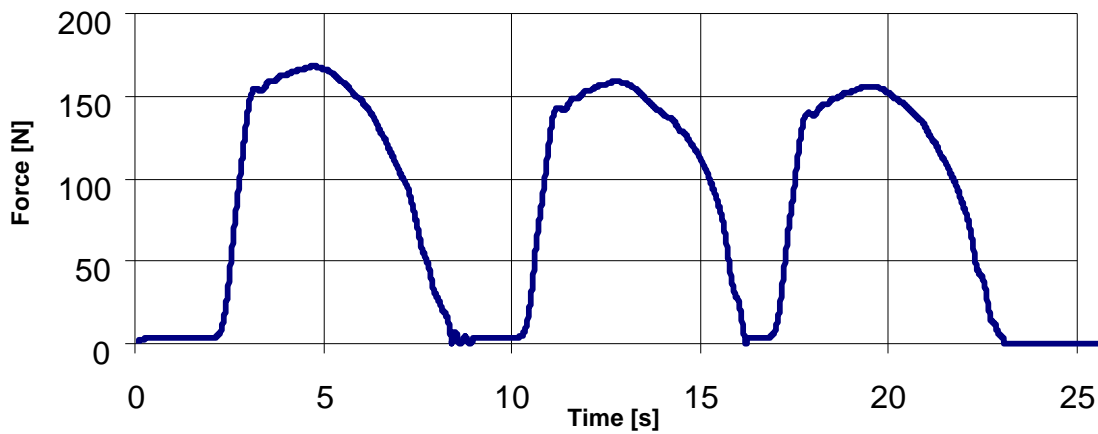

Fig. 96: Force/time diagrams of closing of the left-hand side flap, measurement of the pulling force by means of the complex method

10.1.2.5 Measurement by means of a hand-held force meter:
Closing of the side flap (right) of a combine harvester



Fig. 97 and Fig. 98: Closing of the right-hand side flap on a combine harvester (John Deere T560): measurement of the pushing force by means of a hand-held force meter, force transmission through a plastic mat to prevent damage to the surface, test subject 4

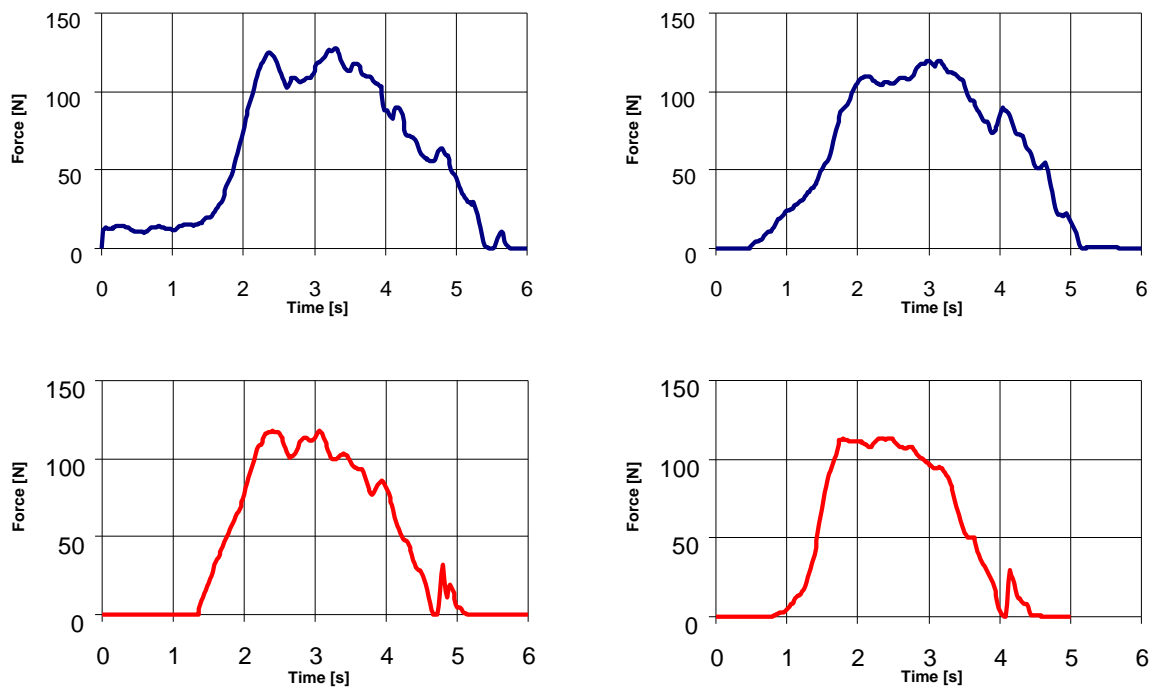

Fig. 99: Force/time diagrams of closing of the right-hand side flap, measurement of the pushing force by means of a hand-held force meter. The measurements return similar results when performed by different test subjects. Graphs top (blue): test subject 4; graphs bottom (red): test subject 2

10.1.2.6 Measurement by means of the complex method:
Closing of the side flap (right) of a combine harvester



Fig. 100: Closing of the left-hand side flap on a combine harvester (John Deere T560): measurement of the pulling force by means of the complex method

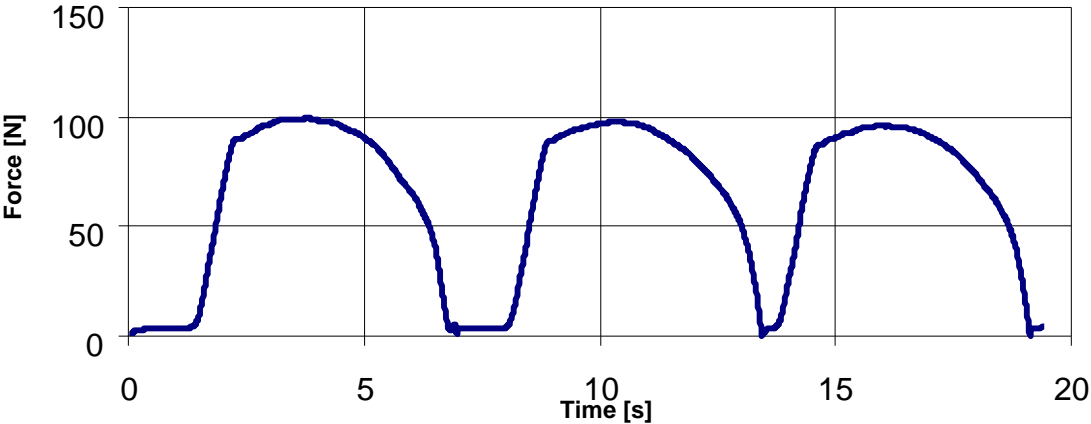

Fig. 101: Force/time diagram of closing of the right-hand side flap: measurement of the pulling force by means of the complex method

10.1.2.7 Measurement by means of a hand-held force meter:
Raising of the chopper of a combine harvester by hand



Fig. 102 and Fig. 103: Raising of the chopper on a combine harvester (John Deere T560). Measurement of the pulling force by means of a hand-held force meter; force transmission by means of a hose clip; test subject 2

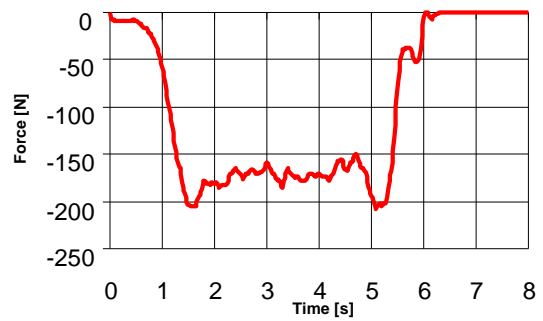
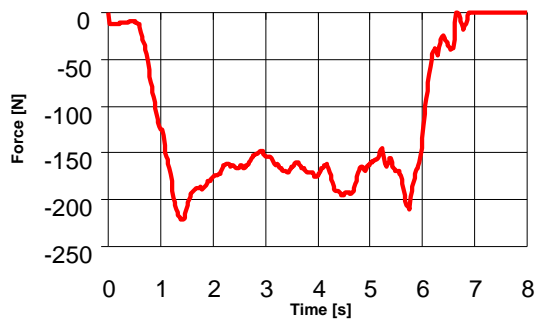
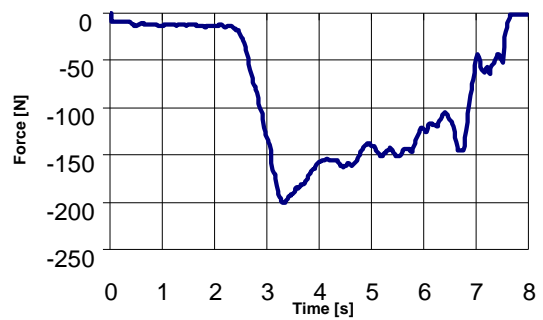
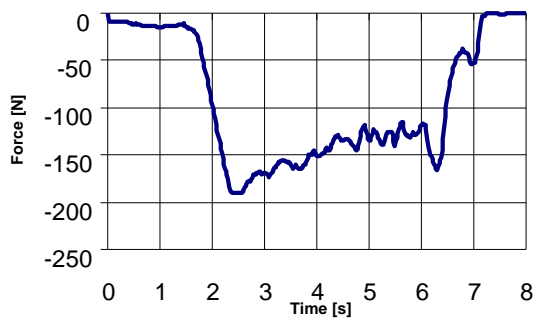

Fig. 104: Force/time diagrams of raising of the chopper, measurement of the pulling force by means of a hand-held force meter. Top (blue): test subject 4; bottom (red): test subject 2

10.1.2.8 Measurement by means of a hand-held force meter:
Closing of the cover on a disk mower



Fig. 105 and Fig. 106: Raising and closing of the cover on a disk mower (Kuhn GMD 600 GII), measurement of the pulling force by means of a hand-held force meter; force transmission by means of a hose clip; test subject 3. For greater clarity, the tarpaulin is transparent

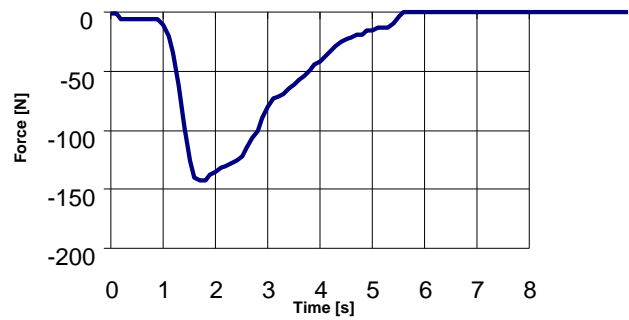
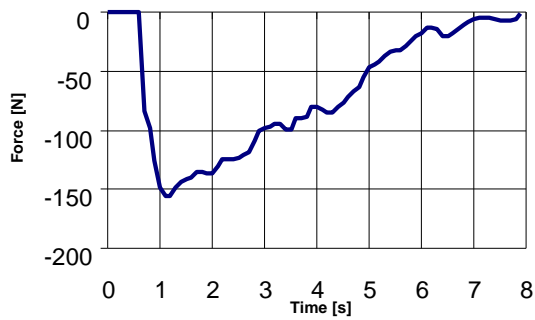

Fig. 107: Force/time diagrams for raising and closing of the cover on a disk mower, test subject 3. The maximum values of the forces exerted are around 155 N and 143 N

10.1.2.9 Measurement by means of a hand-held force meter: Closing of the seed flap on a seed drill



Fig. 108 and Fig. 109: Closing of the seed flap on a seed drill (Lemken Saphir 7). Measurement of the pulling force with a hand-held force meter, force transmission by means of a hose clip, test subject 3 (left) and test subject 4 (right)

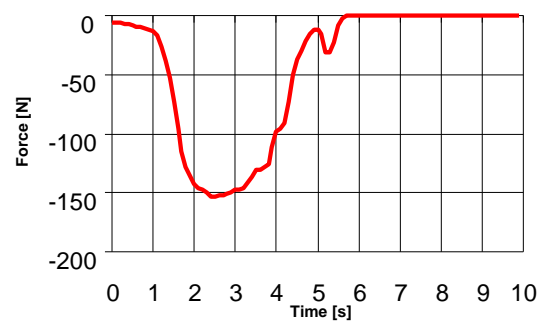
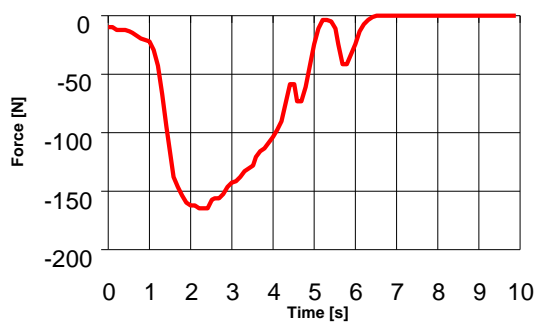
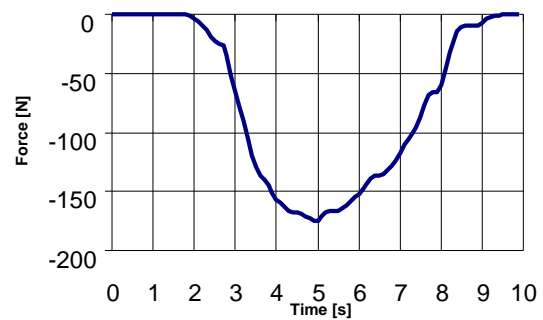
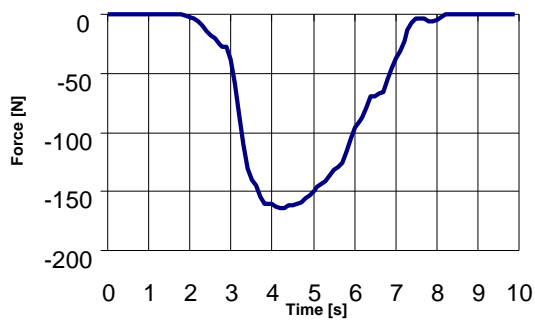

Fig. 110: Force/time diagrams of closing of the seed flap on a seed drill; measurement of the pulling force by means of a hand-held force meter. Graphs top (blue): test subject 3; graphs bottom (red): test subject 4. Test subject 4 performed the movement somewhat faster than test subject 3; the maximum values of the measurements lie between 155 N and 175 N

10.1.2.10 Measurement by means of a hand-held force meter: Closing of the seed flap on a seed drill (Kuhn)



Fig. 111 and Fig. 112: Closing of the seed flap on a seed drill (Kuhn Integra).
Measurement of the pulling force with a hand-held force meter, force transmission by means of a hose clip, test subject 5 (left) and test subject 3 (right)

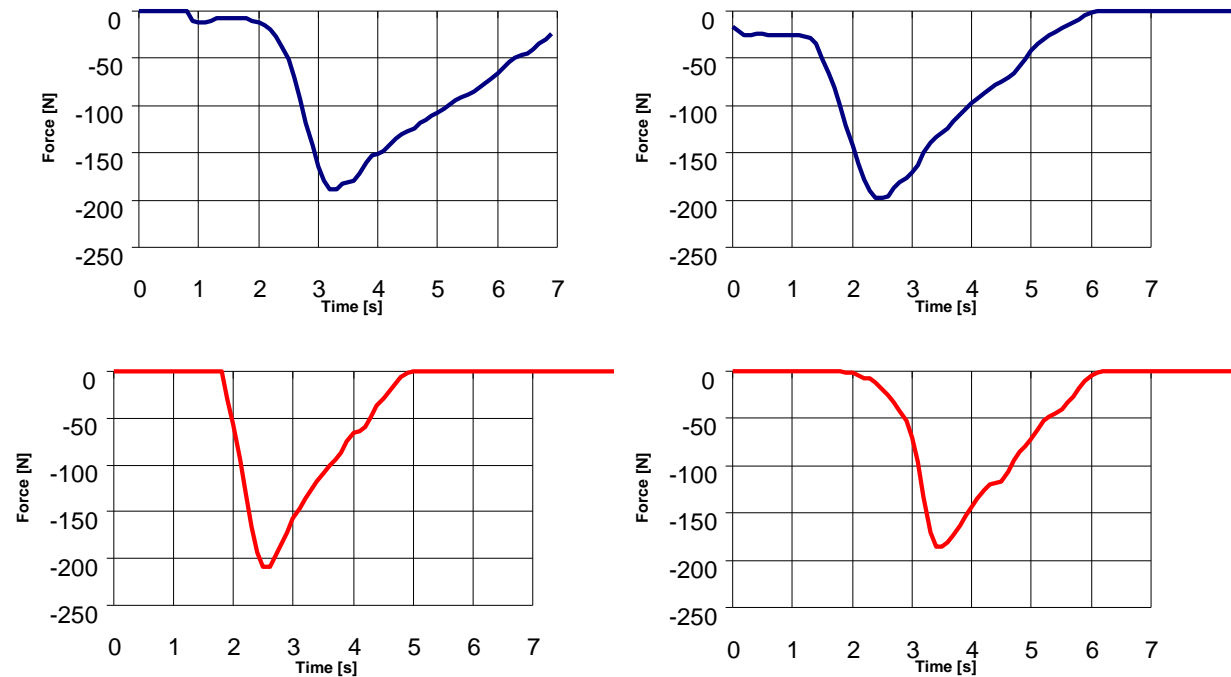

Fig. 113: Force/time diagrams of closing of the seed flap on a seed drill; measurement of the pulling force by means of a hand-held force meter.
Graphs top (blue): test subject 5; graphs bottom (red): test subject 3

The results of the measurements considered here concerning the movement of flaps, covers, shrouds and components are summarized in Table 12.

Table 12: Overview of the force measurements on flaps, covers, shrouds and components*.

Item under test *	Measurement method	Repeats	F_{\max} [N] (mean)	F_{\max} [N] (min)	F_{\max} [N] (max)
Opening rear flap Combine harvester TS2	Hand-held force meter	12	78	67	85
Opening rear flap Combine harvester TS3	Hand-held force meter	12	103	77	122
Closing side flap on round baler TS3	Hand-held force meter	2	183	182	184
Closing left-hand side flap on combine harvester TS2	Hand-held force meter	3	176	170	185
Closing left-hand side flap on combine harvester TS4	Hand-held force meter	3	187	185	190
Closing left-hand side flap on combine harvester TS2	Complex method	3	161	155	168
Closing right-hand side flap on combine harvester TS2	Hand-held force meter	3	122	113	138
Closing right-hand side flap on combine harvester TS4	Hand-held force meter	3	120	118	125
Closing right-hand side flap on combine harvester	Complex method	3	97	96	99
Raising chopper (John Deere T560) TS2	Hand-held force meter	3	210	200	220
Raising chopper (John Deere T560) TS4	Hand-held force meter	3	202	195	205
Closing cover on disk mower TS3	Hand-held force meter	2	149	143	155
Closing seed flap (Lemken) TS3	Hand-held force meter	3	170	165	175
Closing seed flap (Lemken) TS4	Hand-held force meter	2	159	153	165
Closing seed flap (Kuhn) TS3	Hand-held force meter	2	193	188	197
Closing seed flap (Kuhn) TS5	Hand-held force meter	2	197	185	209

* Note: the measurements in the table are guideline values only. The purpose of these measurements was to test the usability of the measurement method. Differences between measurements on the same item under test may be attributable to the absence of a defined final position of the movement. The repetitiveness of measurements was determined in the laboratory, and is described in Section 5.3.

10.1.3 Moving of steps and ladders

10.1.3.1 Measurement by means of a hand-held force meter: Engaging the ladder of a combine harvester



Fig. 114: Engaging the ladder to the grain tank on a combine harvester (Claas Mega 350), test subject 3



Fig. 115: Measurement with a hand-held force meter, fixing of the force application point by means of a magnet, test subject 2

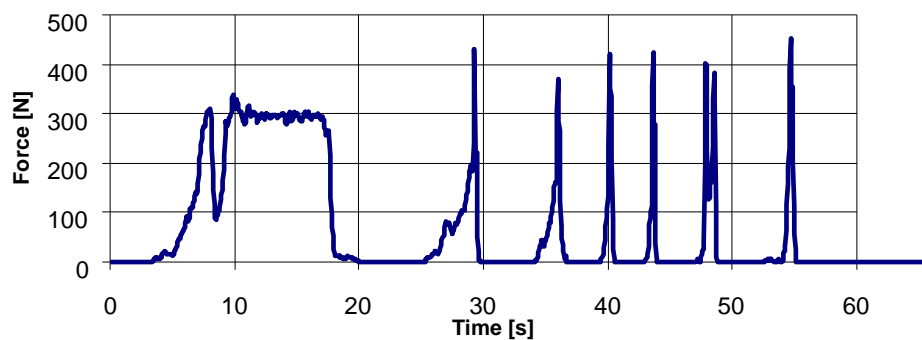

Fig. 116: Force-time diagram of engaging the ladder: measurement with a hand-held force meter, test subject 3. The first curve shows the attempt to build up the force slowly; jerky exertion of force was required in order to engage the ladder

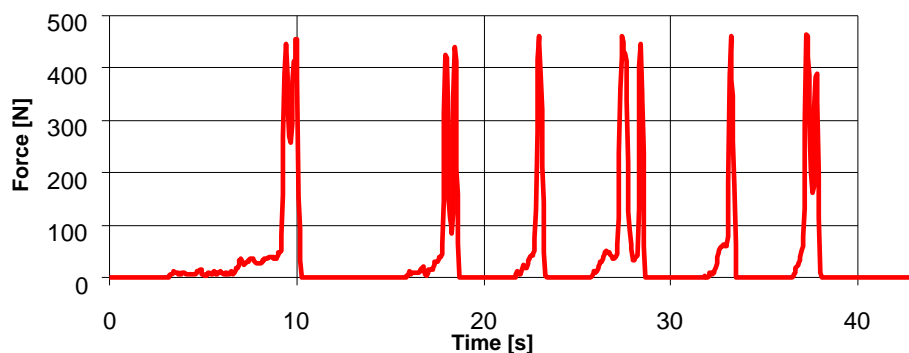

Fig. 117: Force-time diagram of engaging the ladder: measurement with a hand-held force meter, test subject 2. Two force peaks are clearly visible in each cycle: the first peak shows overcoming of the engagement point; the second force peak is caused by the stop for the ladder within the engagement mechanism

10.1.3.2 Measurement by means of a hand-held force meter: Disengaging the ladder of a combine harvester

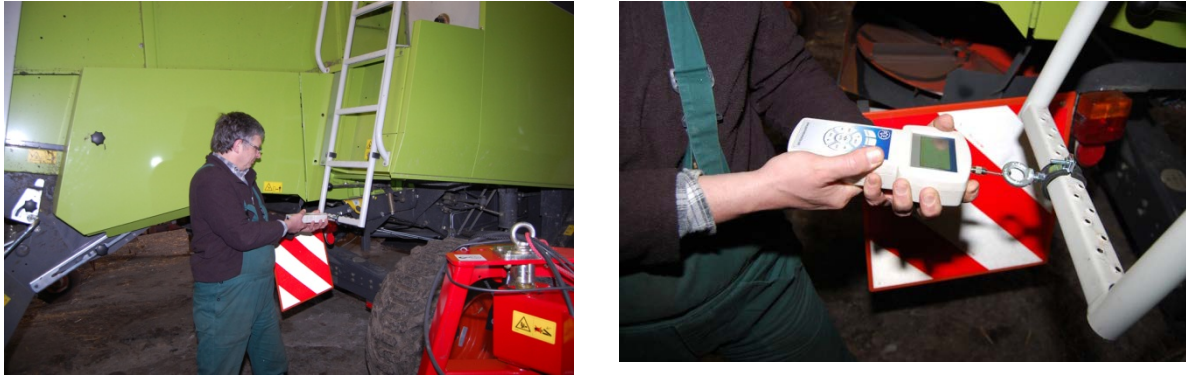

Fig. 118 and Fig. 119: Disengaging the ladder to the grain tank on a combine harvester (Claas Mega 350). Measurement with a hand-held force meter, fixing of the force application point by means of a hose clip, test subject 3

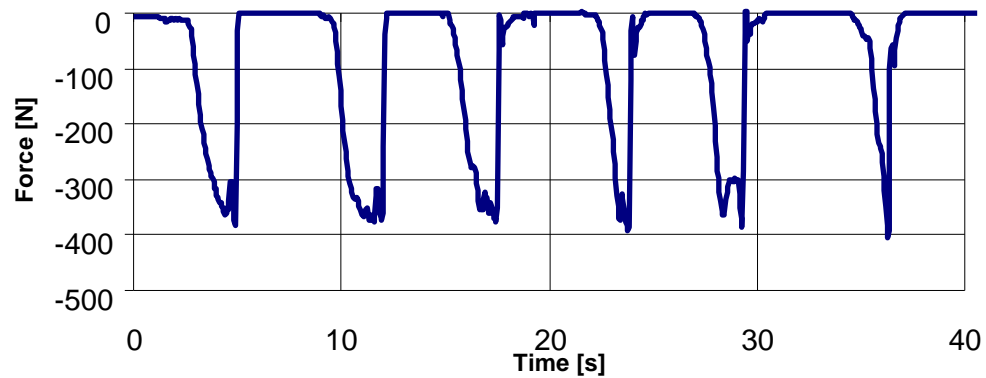

Fig. 120: Force-time diagram of disengaging the ladder, measurement by means of a hand-held force meter, slow force build-up, test subject 2

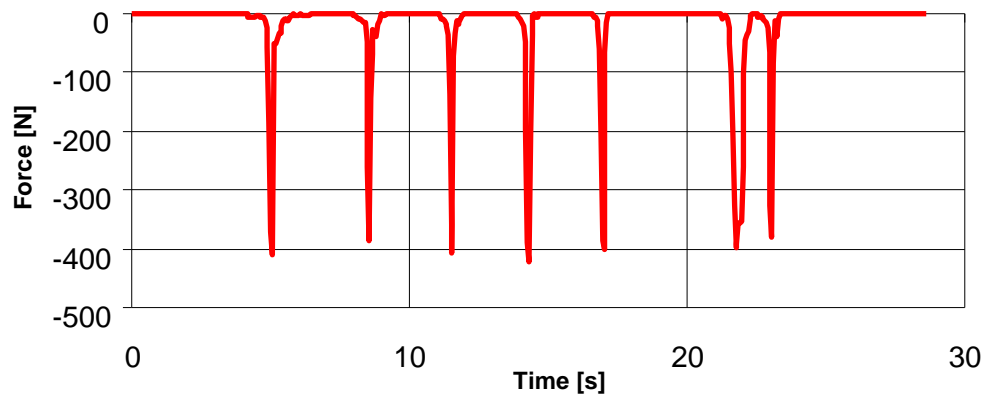

Fig. 121: Time-force diagram of disengaging the ladder. Measurement by means of a hand-held force meter; jerky build-up of force, test subject 2

10.1.3.3 Measurement by means of the transducer: disengaging the ladder to the grain tank, combine harvester (Claas Mega 350)



Fig. 122 and Fig. 123: Disengaging the ladder to the grain tank, combine harvester (Claas Mega 350). Measurement by means of a transducer, fixing of the force application point by means of a hose clip, test subject 2 (left), test subject 3 (right)

Fig. 124: Force-time diagram of disengaging the ladder, measurement by means of a transducer, slow force build-up, test subject 3

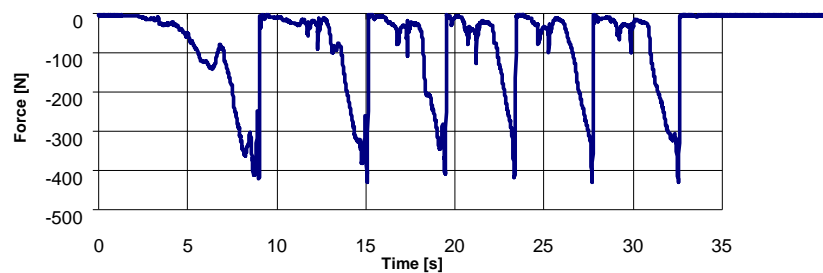

Fig. 125: Force-time diagram of disengaging the ladder, measurement by means of a transducer, slow force build-up, test subject 2

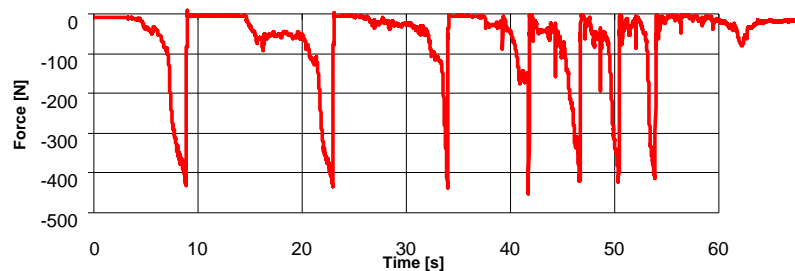
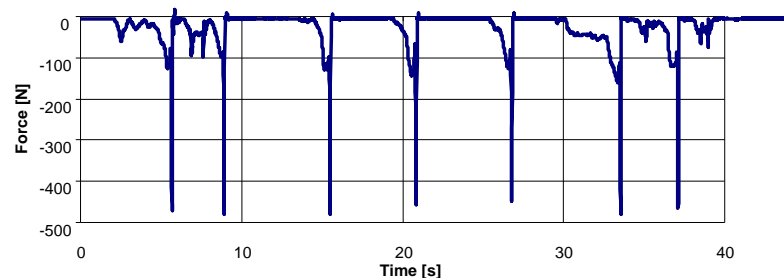

Fig. 126: Force-time diagram of disengaging the ladder, measurement by means of a transducer, fast force build-up, test subject 3



10.1.3.4 Measurement by means of a hand-held force meter: swivelling a ladder to the driver's cab



Fig. 127 and Fig. 128: Rotating the ladder to the driver's cab out and in, combine harvester (Claas Mega 350). Measurement with a hand-held force meter, force application point with rope, test subject 2

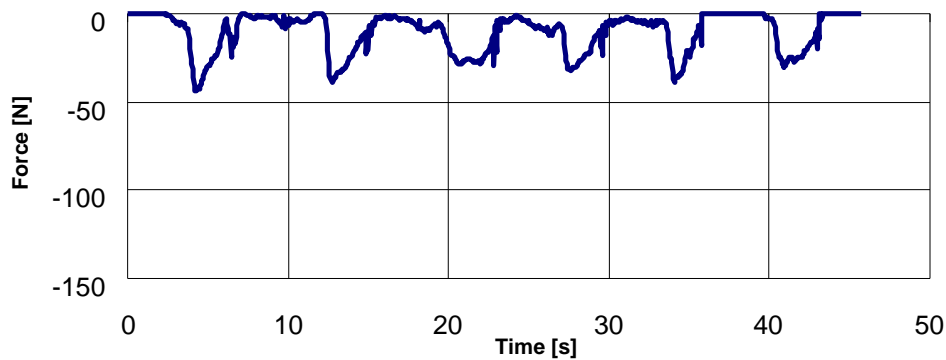

Fig. 129: Force-time diagram of rotating out the ladder to the driver's cab, measurement with a hand-held force meter, slow movement, test subject 2. The force characteristic and maximum value are heavily dependent upon the speed (acceleration) of the movement; a similar but slow movement is difficult for the test subject to maintain

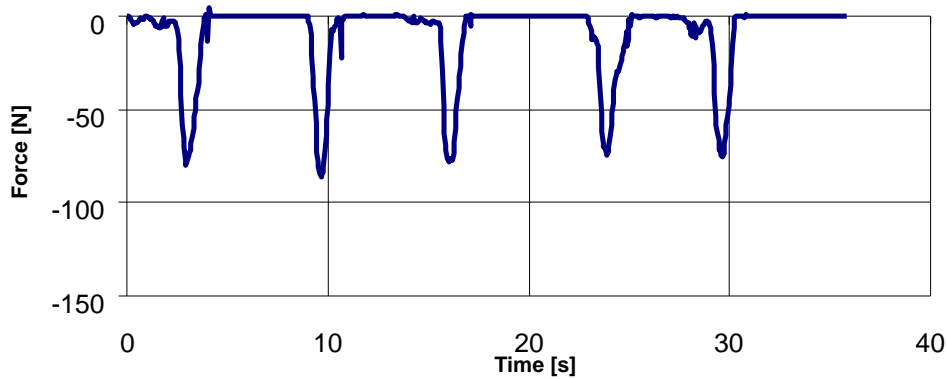

Fig. 130: Force-time diagram of rotating out the ladder to the driver's cab, measurement with a hand-held force meter, fast movement, test subject 2. The maximum force applied is approximately twice as high as that for the slow movement, owing to the higher acceleration

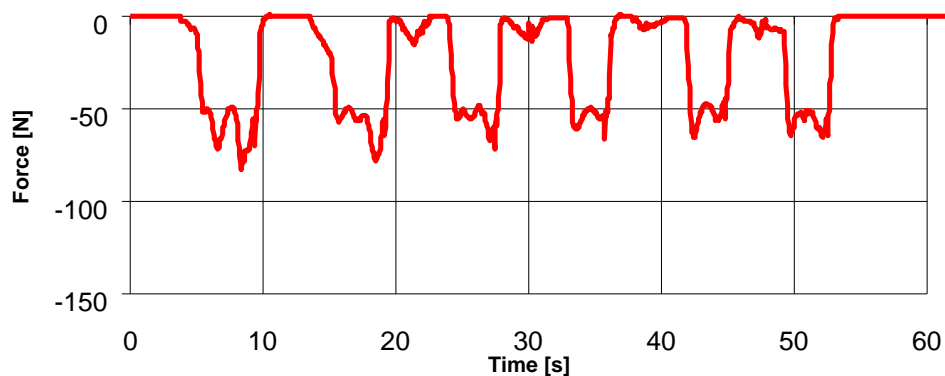

Fig. 131: Force-time diagram of rotating in the ladder to the driver's cab, measurement with a hand-held force meter, slow movement, test subject 2. The force characteristic and maximum value are heavily dependent upon the speed (acceleration) of the movement; a similar but slow movement is difficult for the test subject to maintain

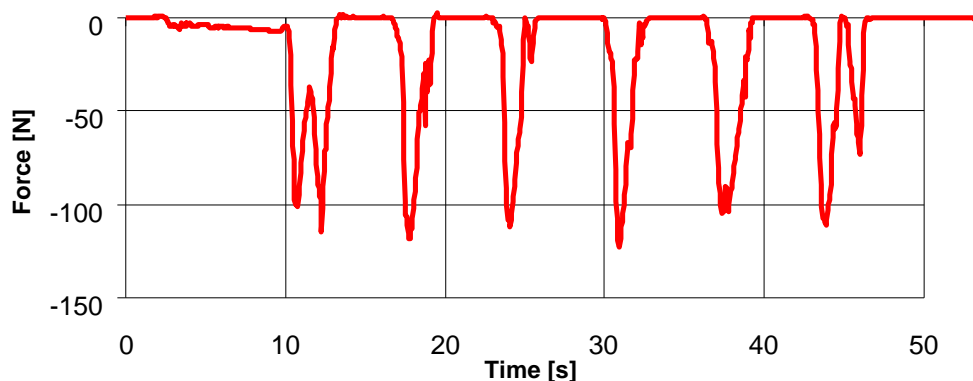

Fig. 132: Force-time diagram of rotating in the ladder to the driver's cab, measurement with a hand-held force meter, fast movement, test subject 2. The maximum force applied is substantially higher than that for the slow movement, owing to the higher acceleration

The results of the measurements considered here during the moving of steps and ladders are summarized in Table 13.

Table 13: Overview of the force measurements on steps and ladders*.

Item under test	Measurement method	Repeats	F_{\max} [N] (mean)	F_{\max} [N] (min)	F_{\max} [N] (max)
Engaging the ladder TS3	Hand-held force measurement	6	413	370	450
Engaging the ladder TS2	Hand-held force measurement	6	450	425	455
Disengaging the ladder (slowly) TS2	Hand-held force measurement	6	384	375	400
Disengaging the ladder (quickly) TS2	Hand-held force measurement	7	401	388	420
Disengaging the ladder (slowly) TS3	Hand-held force measurement	6	415	400	430
Disengaging the ladder (quickly) TS3	Hand-held force measurement	6	418	380	440
Disengaging the ladder (slowly) TS2	Strain sensor (manual)	7	429	415	450
Disengaging the ladder (slowly) TS3	Strain sensor (manual)	6	425	410	430
Disengaging the ladder (quickly) TS2	Strain sensor (manual)	6	467	420	500
Disengaging the ladder (quickly) TS3	Strain sensor (manual)	7	470	450	480
Rotating the ladder out (slowly)	Hand-held force measurement	6	35	29	45
Rotating the ladder out (quickly)	Hand-held force measurement	5	78	75	80
Rotating the ladder in (slowly)	Hand-held force meter	6	71	65	82
Rotating the ladder in (quickly)	Hand-held force meter	6	113	105	122

* Note: the measurements in the table are guideline values only. The purpose of these measurements was to test the usability of the measurement method. Differences between measurements on the same item under test may be attributable to the absence of a defined final position of the movement. The repetitiveness of measurements was determined in the laboratory, and is described in Section 5.3.

Annex 4: Trialling of operating scenarios in the laboratory

Supplement to Section 5.3: laboratory tests on force scenarios similar to those arising on agricultural machinery

10.1.4 Operation of levers

For the operation of levers, a typical lever was fitted to the force measurement apparatus and the operating resistance simulated by three different gas springs. Each lever was operated five times, fast and slowly in each case, by means of a winch (Fig. 133) and manually (Fig. 134).



Fig. 133: Operation of a lever. Measurement assembly with winch (automated speed, strain sensor and angle measurement)



Fig. 134: Operation of a lever. Test subject 5 with hand-held force meter. The meter is held at a 90° angle to the lever

The figures below (Fig. 135 to Fig. 137) show corresponding force/time characteristics. The upper graphs show automated movement, the lower graphs movement performed manually by two test subjects.

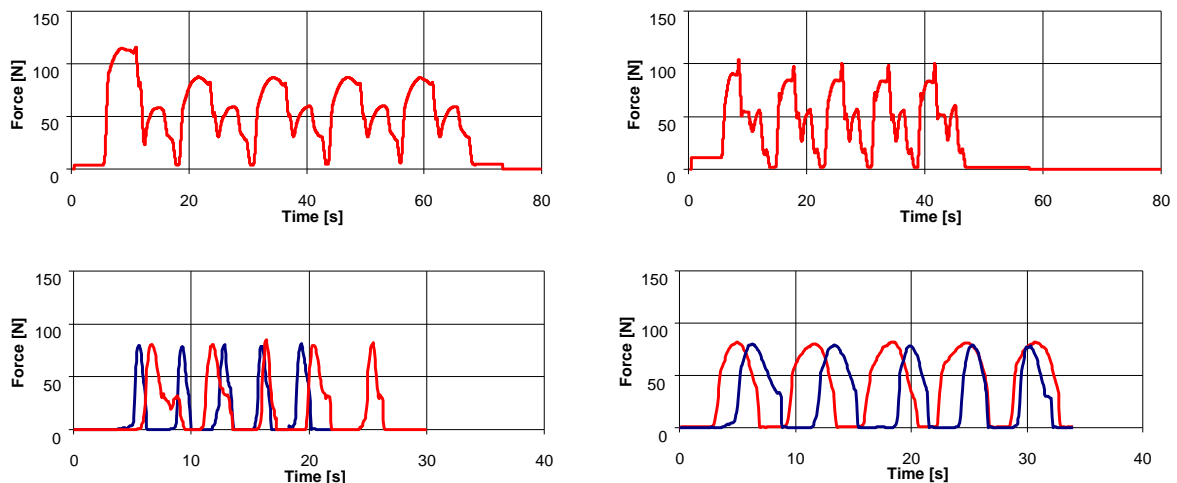

Fig. 135: Operation of a lever, resistance: gas spring 2, five operations, both slowly (graphs left) and quickly (graphs right). Movement with winch (automated speed with angle measurements, graphs top) and manual operation by two test subjects in each case with a hand-held force meter (graphs bottom)

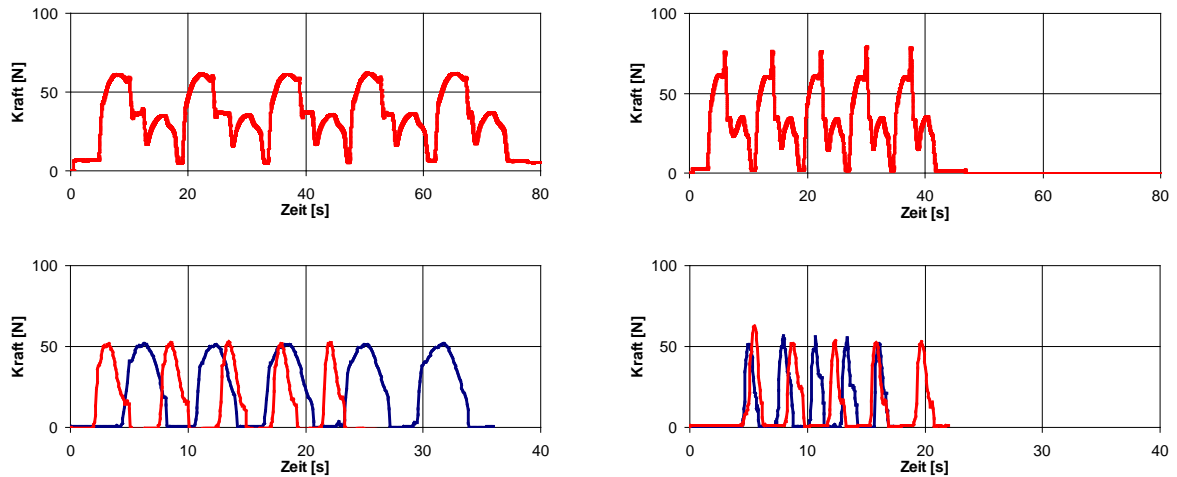

Fig. 136: Operation of a lever, resistance: gas spring 1, five operations in each case and in each case slow (graphs left) and fast (graphs right) movement. Movement with a winch (automated speed with angle measurements, graphs top) and manual operation by two test subjects in each case with a hand-held force meter (graphs bottom)

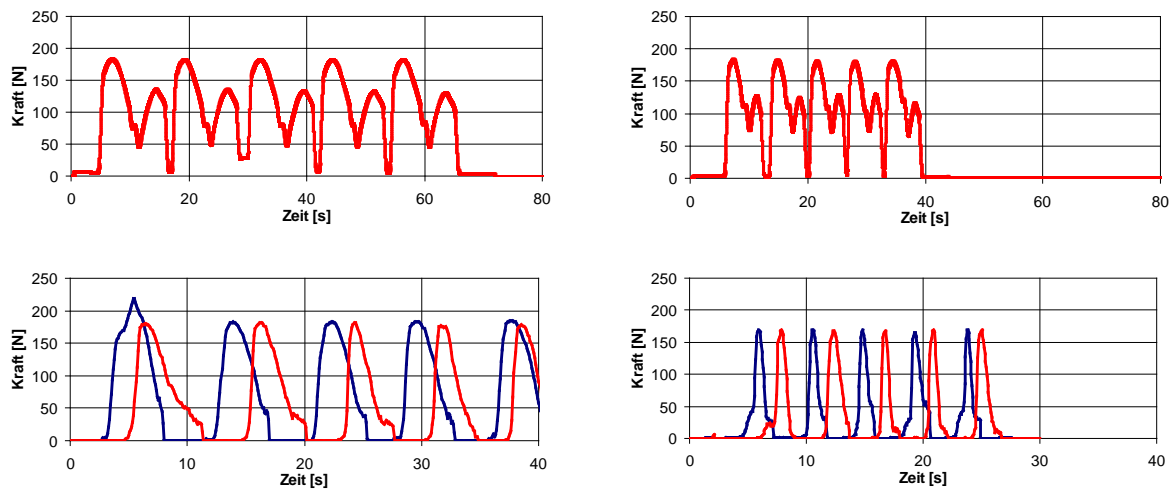

Fig. 137: Operation of a lever, resistance: gas spring 7, five operations in each case and in each case slow (graphs left) and fast (graphs right) movement. Movement with a winch (automated speed with angle measurements, graphs top) and manual operation by two test subjects in each case with a hand-held force meter (graphs bottom)

Note: The upper and lower peaks in the force/time diagrams for the automated movement can be ignored. These are caused by the stopping/starting process of the winch, and are not relevant to the required force exertion.

10.1.5 Swivelling of flaps/covers/shrouds/components

For the swivelling of flaps, covers, shrouds and components, a flap was fitted to the force measurement apparatus by means of which typical side flaps (such as those on combine harvesters and choppers) can be simulated.

10.1.5.1 Closing of a flap

The flap was closed quickly five times and slowly five times against the resistance of each of six different gas springs (Fig. 138):

- By means of a winch (automated speed) (Fig. 139)
- Manually by two test subjects using an electronic hand-held force meter (Fig. 140 and Fig. 141)

The manufacturers state the following data for the gas springs employed (see Fig. 138) (counterforce in the extended position):

- Gas spring 1: 150 N, spring length: 460 mm
- Gas spring 2: 250 N, spring length: 460 mm
- Gas spring 3: 350 N, spring length: 560 mm
- Gas spring 4: 650 N, spring length: 560 mm
- Gas spring 5: 850 N, spring length: 560 mm
- Gas spring 6: 350 N, spring length: 860 mm
- Gas spring 7: 650 N, spring length: 860 mm



Fig. 138: Gas springs of different lengths and pressures used in the laboratory tests



Fig. 139: Closing of a flap. Measurement apparatus with winch (automated speed, pulling force sensor and angle measurement, and integral gas spring)

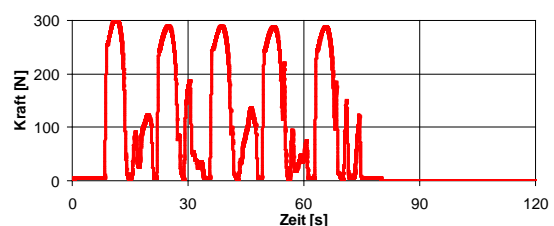
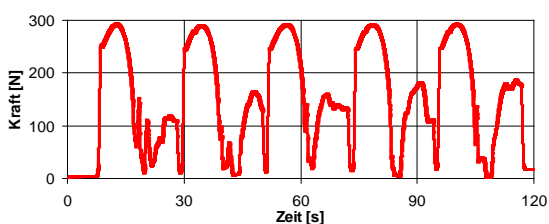

Fig. 140: Closing of a flap. Test subject 2 with hand-held force meter



Fig. 141: Closing of a flap. Test subject 5 with hand-held force meter

Each of the figures below (Fig. 142 to Fig. 147) shows up to four force/time characteristics. In the top graphs, the movement is performed by a winch. This requires angle measurements to be performed concurrently with the force measurement, since the automated motion brought about by the winch does not enable a constant angle of 90° to be maintained to the item under test. The angle between the measurement sensor and the item under test was therefore computed during automated measurement, and subsequently corrected accordingly. The force values shown in the images are those following correction. The force/time characteristics in the lower graphs show manual operation with a hand-held force meter, performed in each case by two test subjects. In some of these cases, the closing movements could be performed only at a moderate speed. The reason for this is that in this case, despite the force at the peak "only" being around 300 N, the flap is not held directly; instead, the force is transmitted to the manually operated part through the hand-held force meter, requiring the test subjects to adopt highly unergonomic hand/arm positions.



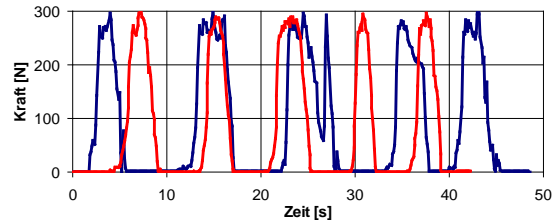

Fig. 142: Closing of a flap, resistance: gas spring 7, long lever, five closing operations performed slowly (graph left) and fast (graph right). Movement with a winch (automated speed with angle measurement, graphs top) and manual operation with a hand-held force meter, in each case by two test subjects (graph bottom). When performed manually, the closing movements were possible only at a moderate speed

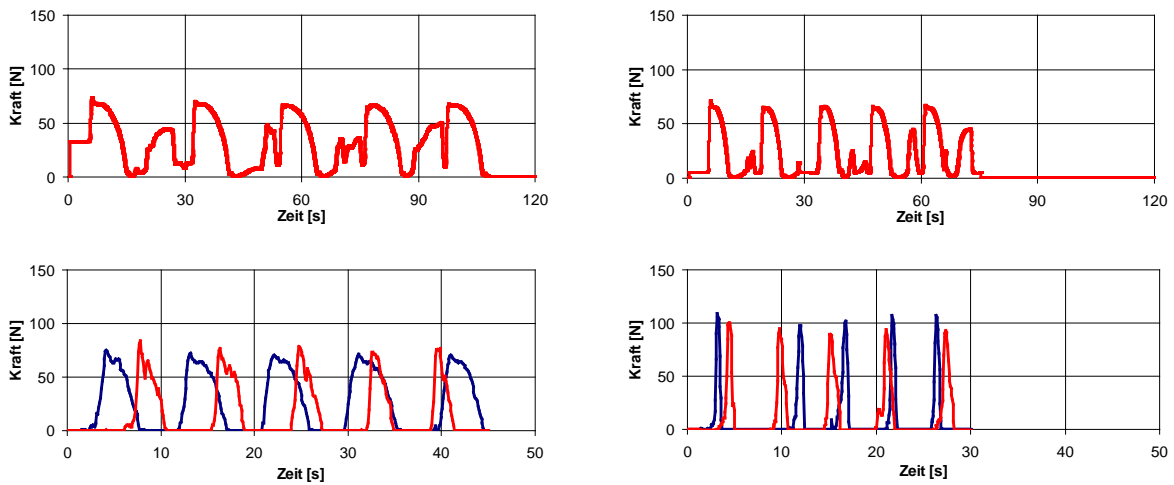

Fig. 143: Closing of a flap, resistance: gas spring 7, short lever, five closing operations each at slow (graphs left) and fast (graphs right) speed. Movement with a winch (automated speed with angle measurement, graphs top) and manual operation with a hand-held force meter, by 2 test subjects in each case (graphs bottom)

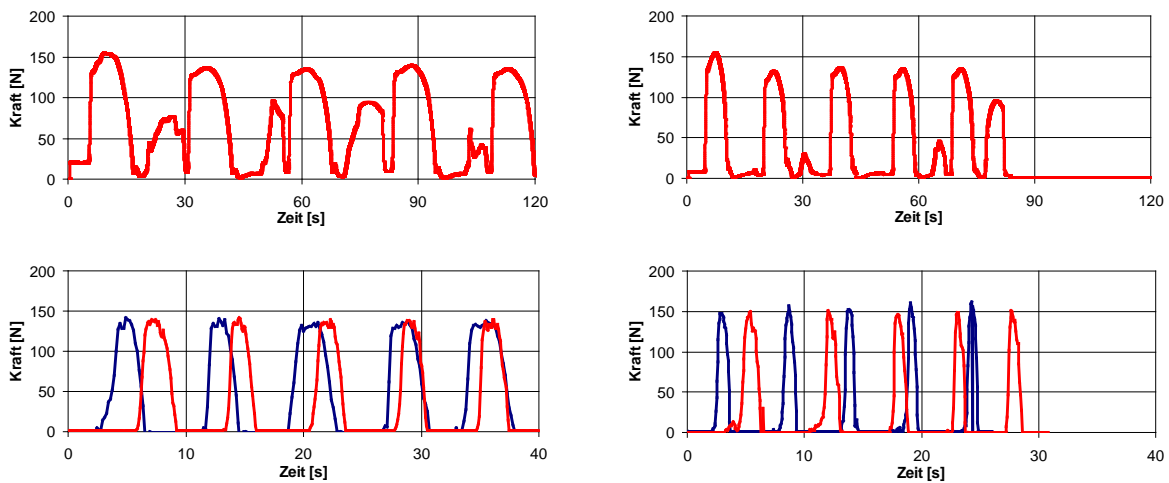

Fig. 144: Closing of a flap, resistance: gas spring 5, short lever, five slow (graphs left) and five fast (graphs right) closing operations. Movement with a winch (automated speed with angle measurement, graphs top) and manual operation with a hand-held force meter, by 2 test subjects in each case (graphs bottom)

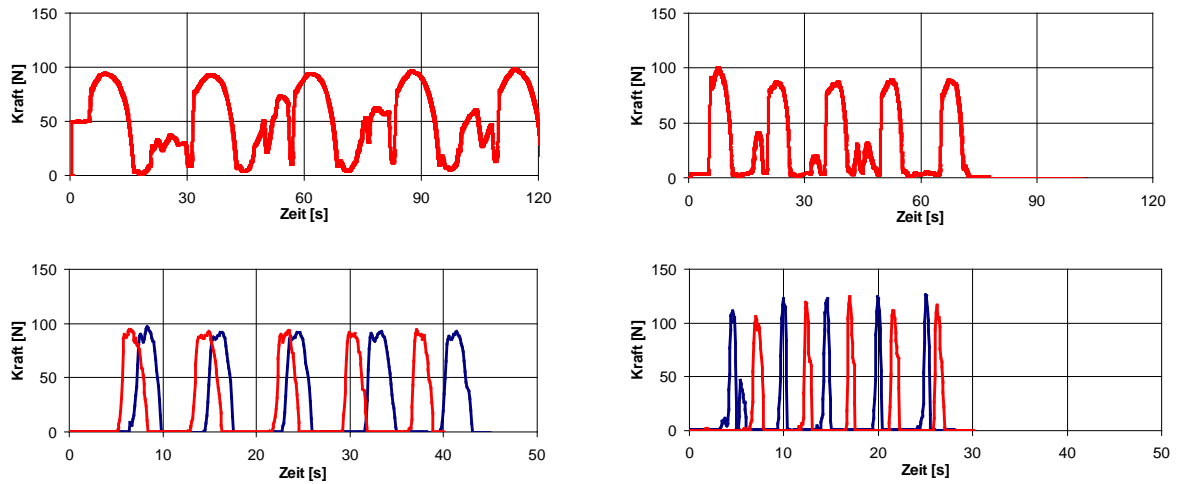

Fig. 145: Closing of a flap, resistance: gas spring 4, short lever, five slow (graphs left) and five fast (graphs right) closing operations. Movement with a winch (automated speed with angle measurement, graphs top) and manual operation with a hand-held force meter, by 2 test subjects in each case (graphs bottom)

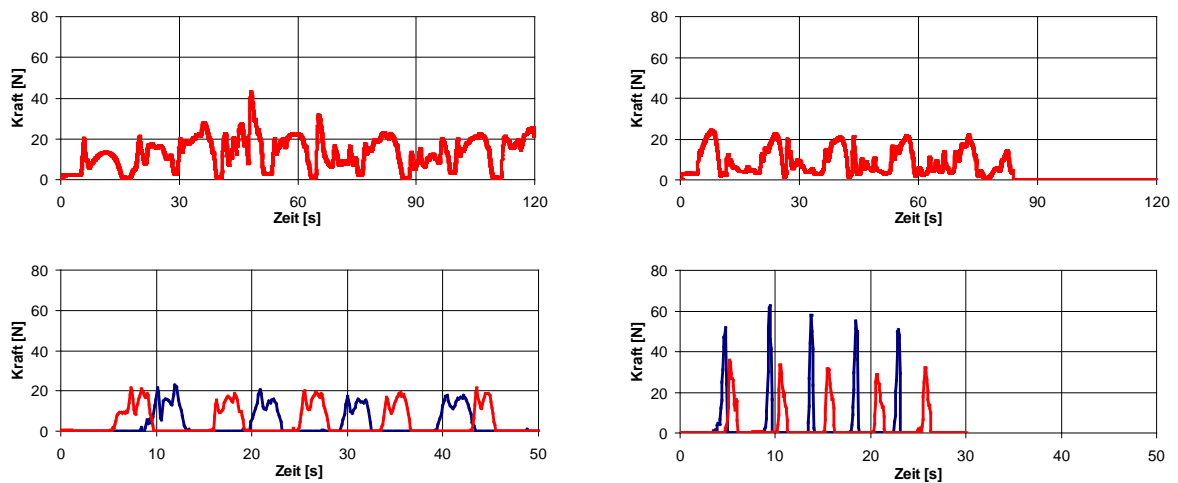
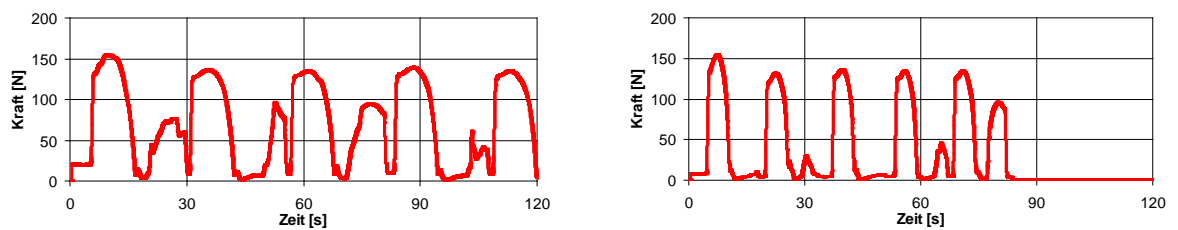

Fig. 146: Closing of a flap, resistance: gas spring 3, short lever, five slow (graphs left) and five fast (graphs right) closing operations. Movement with a winch (automated speed with angle measurement, graphs top) and manual operation with a hand-held force meter, by 2 test subjects in each case (graphs bottom)



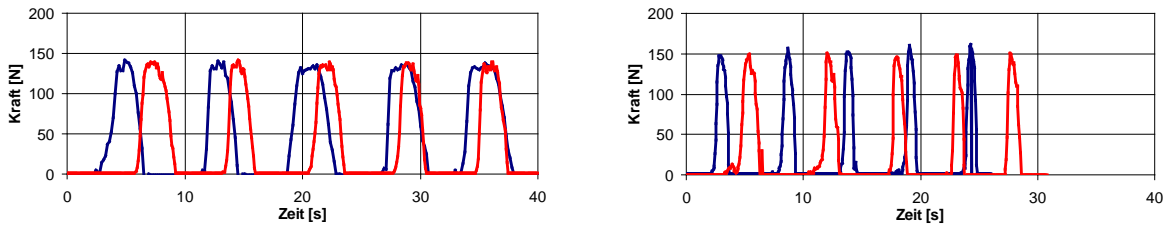

Fig. 147: Closing of a flap, resistance: gas spring 6, short lever, five slow (graphs left) and five fast (graphs right) closing operations. Movement with a winch (automated speed with angle measurement, graphs top) and manual operation with a hand-held force meter, by 2 test subjects in each case (graphs bottom)

10.1.5.2 Raising and lowering of a chopper

The chopper of a combine harvester was simulated on the force measurement apparatus. For this purpose, the flap in the tests described above was fitted in a lower position and loaded with weights, resulting in total weights to be raised of approx. 20 kg, 30 kg, 35 kg and 45 kg.

The chopper was raised from a position of 70° to up to 160° :

- By means of a winch (automated speed), five times quickly and five times slowly (see Fig. 148)
- Manually by two test subjects with an electronic hand-held force meter, each test subject five times quickly and five times slowly (see Fig. 149)



Fig. 148: Raising and lowering of a chopper. Measurement apparatus with winch



Fig. 149: Raising and lowering of a chopper. Test subject 5 with hand-held force meter

Each of the figures below (Fig. 150 to Fig. 153) shows up to four force/time characteristics. In the top graphs, the movement is performed by a winch. The force characteristic and angle measurements are shown. The angle measurements are required because the automated motion brought about by the winch does not enable a constant angle of 90° to be maintained to the item under test. The angle between the measurement sensor and the item under test is therefore computed during automated measurement and subsequently corrected. The force values shown in the images are those following correction.

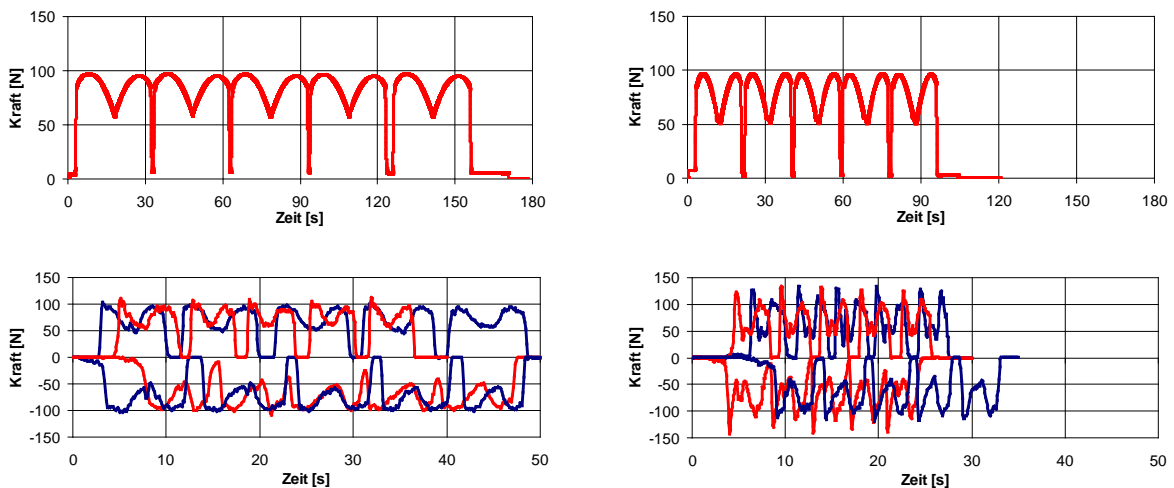

Fig. 150: Raising and lowering of the chopper. Weight: 20 kg, five operations each performed slowly (graphs left) and fast (graphs right). Movement with a winch (automated speed with angle measurement, graphs top) and manual operation with a hand-held force meter, in each case by two test subjects, in each case pushing and pulling with the instrument (graphs bottom)

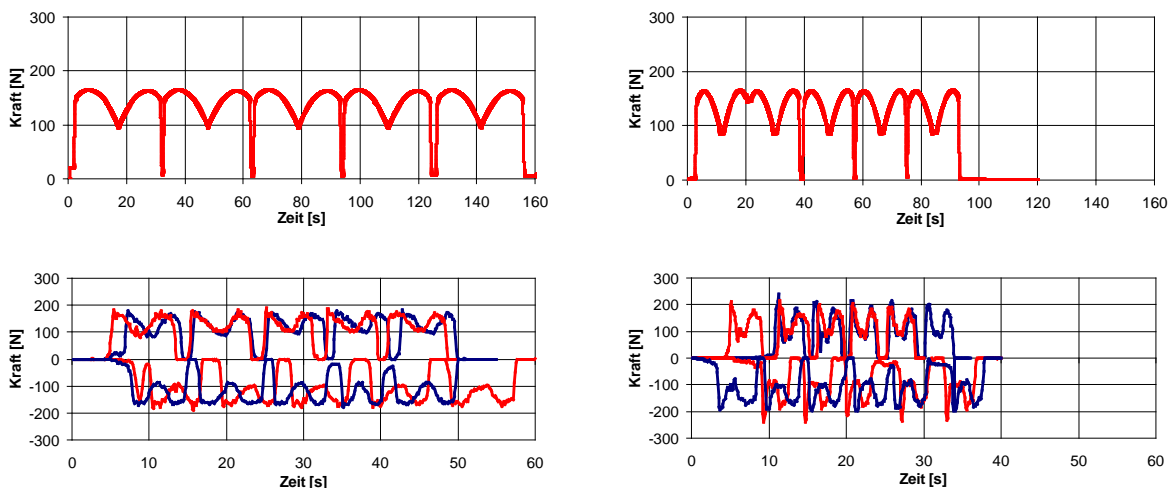

Fig. 151: Raising and lowering of the chopper. Weight: 30 kg, five operations each performed slowly (graphs left) and fast (graphs right). Movement with a winch (automated speed with angle measurement, graphs top) and manual operation with a hand-held force meter, in each case by two test subjects, in each case pushing and pulling with the instrument (graphs bottom)

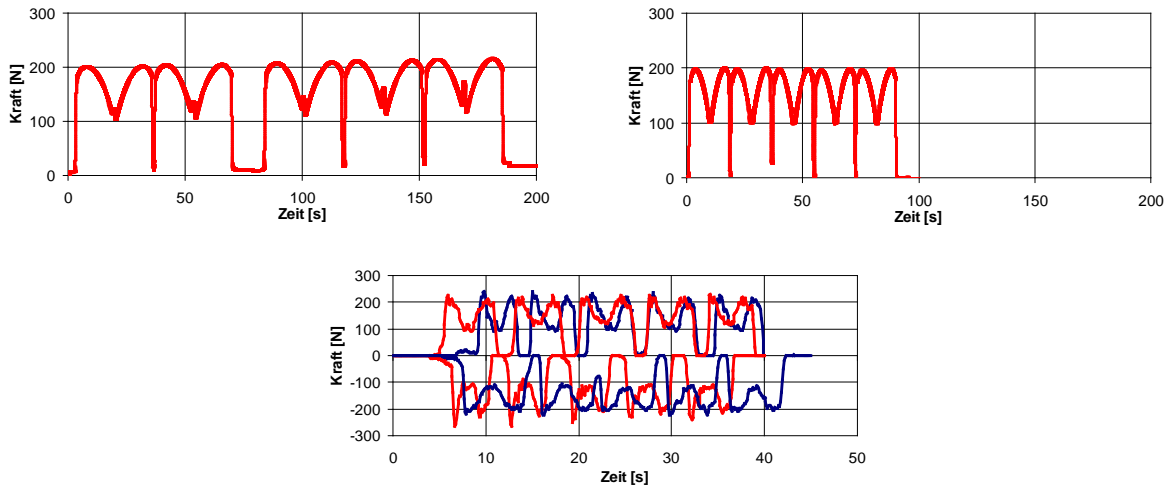

Fig. 152: Raising and lowering of the chopper. Weight: 35 kg, five operations each performed slowly (graph left) and fast (graph right). Movement with a winch (automated speed with angle measurement, graphs top) and manual operation with a hand-held force meter, in each case by two test subjects, in each case pushing and pulling with the instrument (graph bottom). The movements could be performed only at one speed

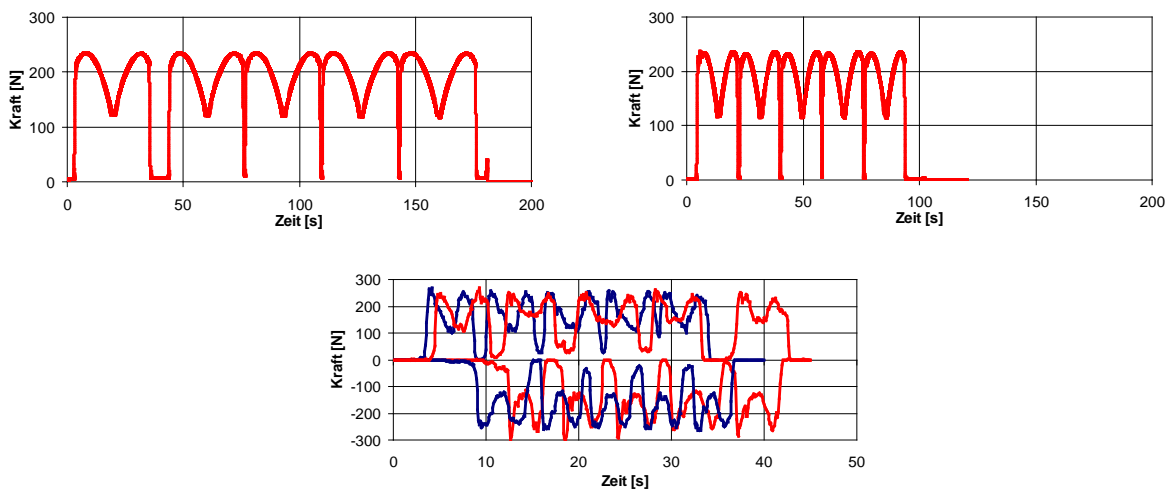

Fig. 153: Raising and lowering of the chopper. Weight: 45 kg, five operations each performed slowly (graph left) and fast (graph right). Movement with a winch (automated speed with angle measurement, graphs top) and manual operation with a hand-held force meter, in each case by two test subjects and in each case pushing and pulling with the instrument (graph bottom). The movements could be performed only at one speed

10.1.6 Moving of steps and ladders

This section discusses the engagement and disengagement of folding ladders. Folding ladders are very frequently found on combine harvesters for access to the grain tank and roof of the machine. The tests were performed by two test subjects using a hand-held force meter (Fig. 155), and by means of a winch (only for disengagement of the ladder) (Fig. 154). Since such movements are usually jerky in practice, no attempt was made to perform the test at low speed.



Fig. 154: Disengagement of a ladder. Measurement apparatus with winch



Fig. 155: Disengagement of a ladder. Test subject 5 with hand-held force meter

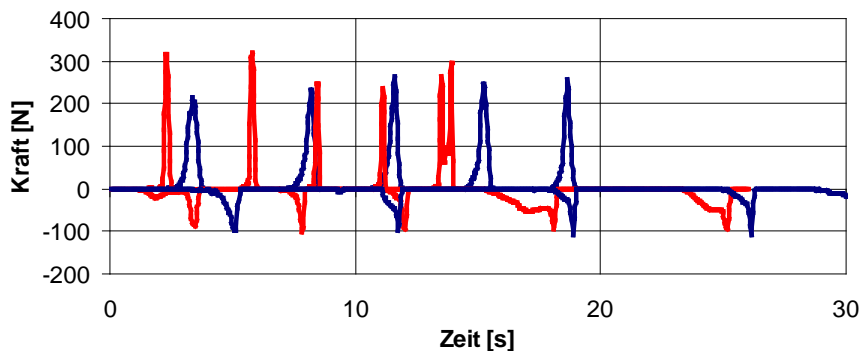

Fig. 156: Engagement (positive values) and disengagement (negative values) of a ladder. 5 operations in each case performed by 2 test subjects with a hand-held force meter

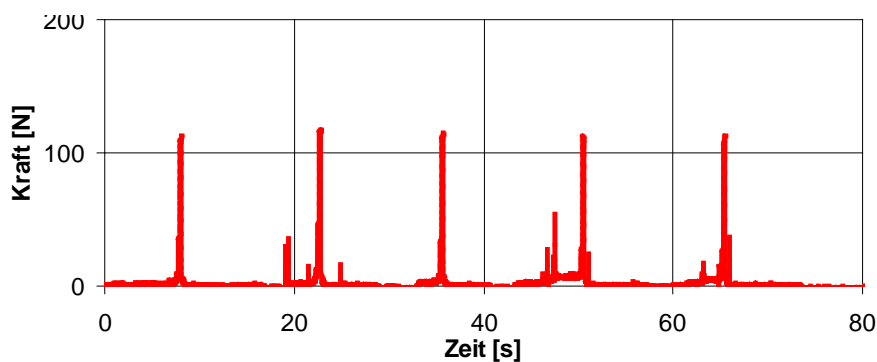

Fig. 157: Disengagement of a ladder. Performance of five operations. Movement with a winch (automated speed)

Annex 5: Results of force measurements

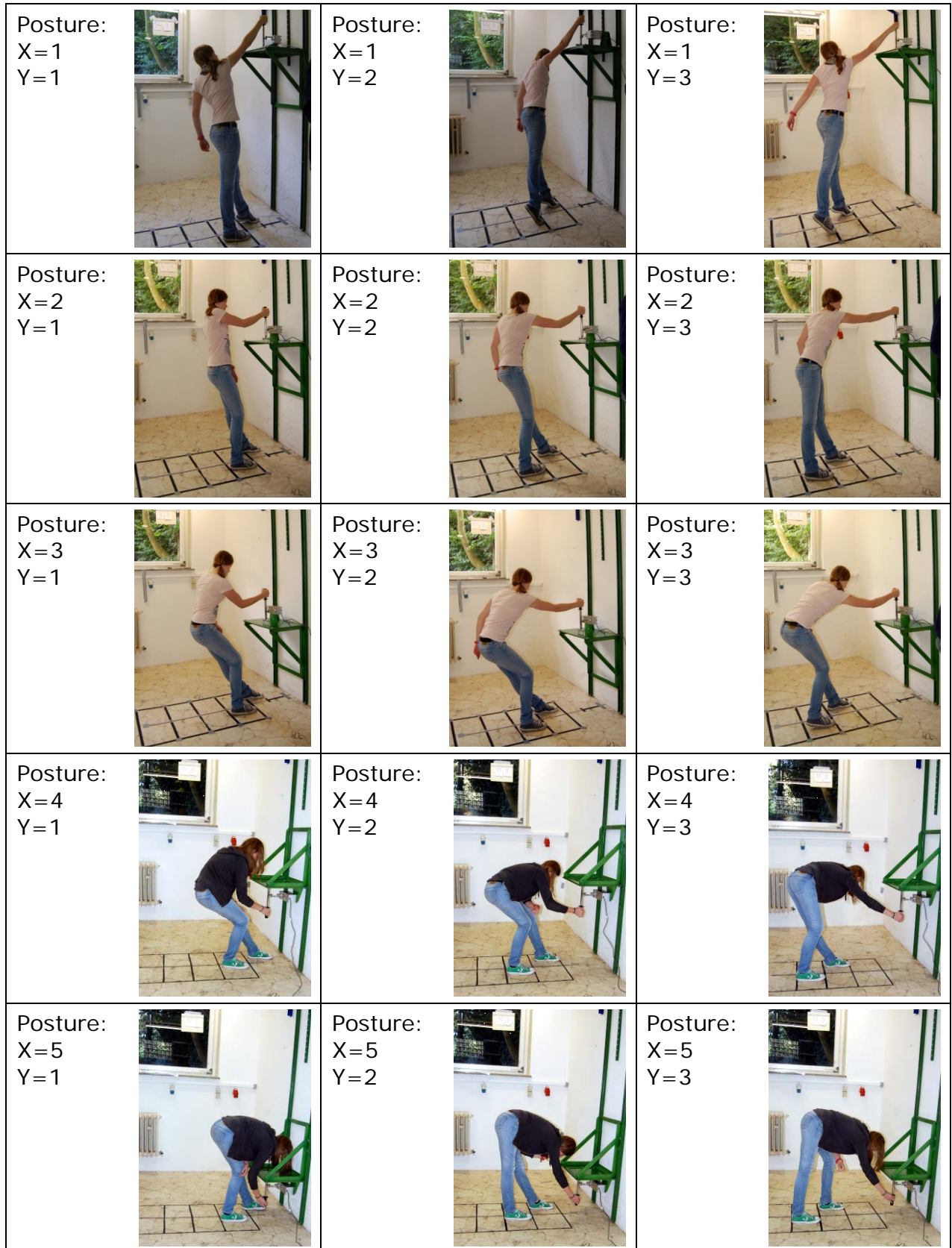

Fig. 158: The 15 body postures, shown with reference to the example of pulling the lever towards the body (direction of force B+)



Fig. 159: The 15 body postures, shown with reference to the example of pulling/pushing the lever up/down (direction of force A+ /A-)

10.1.6.1 Pulling the lever towards the body (direction of force B+).

Table 14: Maximum force values exerted by the men and women for the force scenario: Pulling the lever towards the body (direction of force B+), one-handed operation. The values shown here are the maximum force averaged over 12 measurements in each case (force), the standard deviation (SD), and the percentage deviation from the highest value measured in the direction of force concerned (%). Fields highlighted in grey: maximum values attained for this force scenario

Men		Horizontal distance Y from the back of the foot to the lever								
F_{max} = 520 N		Y = 1: 50 cm			Y = 2: 80 cm			Y = 3: 110 cm		
No	Height X [cm]	Force [N]	SD [N]	%	Force [N]	SD [N]	%	Force [N]	SD [N]	%
1	215	234	44	45	231	36	44	184	38	35
2	158	353	80	68	328	67	63	296	51	57
3	120	409	103	79	405	85	78	348	74	67
4	50	506	85	97	520	64	100	441	84	85
5	15	428	71	82	470	63	90	349	74	67
Women		Horizontal distance Y from the back of the foot to the lever								
F_{max} = 303 N		Y = 1: 46 cm			Y = 2: 73 cm			Y = 3: 101 cm		
No	Height X [cm]	Force [N]	SD [N]	%	Force [N]	SD [N]	%	Force [N]	SD [N]	%
1	197	99	21	33	95	19	31	66	17.5	22
2	145	168	41	55	159	26	52	137	37	45
3	110	209	37	69	213	32	70	170	37	56
4	46	294	67	97	303	77	100	223	50	73
5	14	220	50	72	220	66	72	196	59	65

10.1.6.2 Pushing the lever away from the body towards the machine (direction of force B-).

Table 15: Maximum force values exerted by the men and women for the force scenario: Pushing the lever away from the body towards the machine (direction of force B-), one-handed operation. The values shown here are the maximum force averaged over 12 measurements in each case (force), the standard deviation (SD), and the percentage deviation from the highest value measured in the direction of force concerned (%).

Fields highlighted in grey: maximum values attained for this force scenario

Men		Horizontal distance Y from the back of the foot to the lever								
F_{max} = 415 N		Y = 1: 50 cm			Y = 2: 80 cm			Y = 3: 110 cm		
No	Height X [cm]	Force [N]	SD [N]	%	Force [N]	SD [N]	%	Force [N]	SD [N]	%
1	215	194	43	47	225	39	54	239	40	58
2	158	268	27	64	330	73	80	410	70	99
3	120	415	61	100	404	71	97	413	109	100
4	50	358	78	86	378	117	91	330	62	79
5	15	220	30	53	294	50	71	300	98	72
Women		Horizontal distance Y from the back of the foot to the lever								
F_{max} = 249 N		Y = 1: 46 cm			Y = 2: 73 cm			Y = 3: 101 cm		
No	Height X [cm]	Force [N]	SD [N]	%	Force [N]	SD [N]	%	Force [N]	SD [N]	%
1	197	89	25	36	109	20	44	126	36	51
2	145	123	33	49	167	47	67	223	57	89
3	110	219	72	88	220	64	88	216	33	87
4	46	249	81	100	204	92	82	205	91	82
5	14	128	47	51	153	57	61	154	45	62

10.1.6.3 Pushing the lever to the palm side of the hand (direction of force C+).

Table 16: Maximum force values exerted by the men and women for the force scenario: Pushing the lever to the palm side of the hand (direction of force C+), one-handed operation. The values shown here are the maximum force averaged over 12 measurements in each case (force), the standard deviation (SD), and the percentage deviation from the highest value measured in the direction of force concerned (%).

Fields highlighted in grey: maximum values attained for this force scenario

Men		Horizontal distance Y from the back of the foot to the lever								
F_{max} = 287 N		Y = 1: 50 cm			Y = 2: 80 cm			Y = 3: 110 cm		
No	Height X [cm]	Force [N]	SD [N]	%	Force [N]	SD [N]	%	Force [N]	SD [N]	%
1	215	125	18	44	117	21	41	89	13	31
2	158	231	31	80	197	29	69	144	23	50
3	120	287	48	100	241	45	84	170	25	59
4	50	167	27	93	208	61	73	165	27	57
5	15	174	34	61	174	27	61	115	23	40
Women		Horizontal distance Y from the back of the foot to the lever								
F_{max} = 179 N		Y = 1: 50 cm			Y = 2: 80 cm			Y = 3: 110 cm		
No	Height X [cm]	Force [N]	SD [N]	%	Force [N]	SD [N]	%	Force [N]	SD [N]	%
1	197	67	18	37	63	17	35	42	9	23
2	145	105	24	59	86	21	48	65	15	36
3	110	162	43	90	125	34	70	76	13	42
4	46	179	89	100	124	30	69	95	35	53
5	14	136	52	76	109	58	61	85	41	47

10.1.6.4 Pulling the lever towards the back of the hand (direction of force C-).

Table 17: Maximum force values exerted by the men and women for the force scenario: Pulling the lever towards the back of the hand (direction of force C-), one-handed operation. The values shown here are the maximum force averaged over 12 measurements in each case (force), the standard deviation (SD), and the percentage deviation from the highest value measured in the direction of force concerned (%).

Fields highlighted in grey: maximum values attained for this force scenario

Men		Horizontal distance Y from the back of the foot to the lever									
F_{max} = 283 N		Y = 1: 50 cm			Y = 2: 80 cm			Y = 3: 110 cm			
No	Height X [cm]	Force [N]	SD [N]	%	Force [N]	SD [N]	%	Force [N]	SD [N]	%	
1	215	142	25	50	126	26	44	85	12	30	
2	158	266	35	94	217	23	77	157	23	56	
3	120	283	63	100	231	52	82	152	35	54	
4	50	275	37	97	218	30	77	144	29	51	
5	15	257	73	91	171	45	61	118	40	42	
r											
Women		Horizontal distance Y from the back of the foot to the lever									
F_{max} = 192 N		Y = 1: 50 cm			Y = 2: 80 cm			Y = 3: 110 cm			
No	Height X [cm]	Force [N]	SD [N]	%	Force [N]	SD [N]	%	Force [N]	SD [N]	%	
1	197	60	16	31	56	13	29	39	7	20	
2	145	134	31	69	107	22	55	70	11	36	
3	110	193	38	100	135	26	70	77	13	40	
4	46	185	74	96	171	55	89	119	27	62	
5	14	163	81	85	138	79	71	109	54	57	

10.1.6.5 Pushing/pulling the lever upwards (direction of force A+).

Table 18: Maximum force values exerted by the men and women for the force scenario: Pushing/pulling the lever upwards (direction of force A+), one-handed operation. The values shown here are the maximum force averaged over 12 measurements in each case (force), the standard deviation (SD), and the percentage deviation from the highest value measured in the direction of force concerned (%).

Fields highlighted in grey: maximum values attained for this force scenario

Men		Horizontal distance Y from the back of the foot to the lever								
F_{max} = 736 N		Y = 1: 50 cm			Y = 2: 80 cm			Y = 3: 110 cm		
No	Height X [cm]	Force [N]	SD [N]	%	Force [N]	SD [N]	%	Force [N]	SD [N]	%
1	215	728	228	99	679	191	92	628	203	85
2	158	655	156	89	575	143	78	262	30	36
3	120	590	147	80	494	109	67	298	104	40
4	50	589	147	94	410	60	56	258	49	35
5	15	736	98	100	511	117	69	238	39	32
Women		Horizontal distance Y from the back of the foot to the lever								
F_{max} = 363 N		Y = 1: 50 cm			Y = 2: 80 cm			Y = 3: 110 cm		
No	Height X [cm]	Force [N]	SD [N]	%	Force [N]	SD [N]	%	Force [N]	SD [N]	%
1	197	359	146	99	363	151	100	321	104	88
2	145	281	70	77	291	100	80	124	59	34
3	110	222	63	61	220	87	60	123	75	34
4	46	334	92	92	255	45	70	119	23	33
5	14	346	96	95	310	85	85	268	102	74

10.1.6.6 Pushing/pulling the lever downwards (direction of force A-).



Table 19: Maximum force values exerted by the men and women for the force scenario: Pushing/pulling the lever downwards (direction of force A-), one-handed operation. The values shown here are the maximum force averaged over 12 measurements in each case (force), the standard deviation (SD), and the percentage deviation from the highest value measured in the direction of force concerned (%).

Fields highlighted in grey: maximum values attained for this force scenario

Men		Horizontal distance Y from the back of the foot to the lever								
F_{max} = 669 N		Y = 1: 50 cm			Y = 2: 80 cm			Y = 3: 110 cm		
No	Height X [cm]	Force [N]	SD [N]	%	Force [N]	SD [N]	%	Force [N]	SD [N]	%
1	215	586	83	88	531	112	79	480	106	72
2	158	525	92	79	532	80	80	455	83	68
3	120	573	172	86	533	158	80	475	138	71
4	50	669	97	100	589	82	88	505	66	76
5	15	607	115	91	599	109	90	584	105	87
Women		Horizontal distance Y from the back of the foot to the lever								
F_{max} = 387 N		Y = 1: 50 cm			Y = 2: 80 cm			Y = 3: 110 cm		
No	Height X [cm]	Force [N]	SD [N]	%	Force [N]	SD [N]	%	Force [N]	SD [N]	%
1	197	291	48	75	280	54	72	260	49	67
2	145	300	44	77	301	33	78	269	74	69
3	110	269	49	69	238	61	61	218	65	56
4	46	388	76	100	382	90	98	374	68	97
5	14	363	80	94	349	78	90	343	54	89

10.1.7 Swivelling of flaps, covers, shrouds and other components



Table 20: Maximum forces exerted by the men and women on swivelling components in a number of installation positions; two-handed operation. The figures stated are the maximum force averaged over 12 measurements in each case (force), the standard deviation (SD), and the percentage deviation from the highest value measured in the direction of force concerned (%). The fields highlighted in grey are the maximum values attained for this force scenario

		Flap position and height								
F_{max} = 1.241 N Men										
F_{max} = 585 N Women										
Men		Angle: 90°			Angle: 45°			Angle: 0°		
No	Direction	Height [cm]	Force [N]	SD [N]	Height [cm]	Force [N]	SD [N]	Height [cm]	Force [N]	SD [N]
1	Opening	215	1,007	191	161	648	271	158	362	315
	Closing		887	70		380	272		569	331
2	Opening	192	646	95	138	468	124	120	499	176
	Closing		858	129		341	141		600	104
3	Opening	122	691	73	79	1,241	177	50	714	188
	Closing		703	54		561	117		500	167
Women		Angle: 90°			Angle: 45°			Angle: 0°		
No	Direction	Height [cm]	Force [N]	SD [N]	Height [cm]	Force [N]	SD [N]	Height [cm]	Force [N]	SD [N]
1	Opening	196	585	73	142	374	58	145	173	9
	Closing		504	13		246	24		248	29
2	Opening	175	350	26	121	295	55	110	234	11
	Closing		444	15		163	15		281	16
3	Opening	111	288	35	68	572	57	46	308	31
	Closing		330	31		314	13		243	21

10.1.8 Operation of steps and ladders

Table 21: Maximum forces exerted by the men and women during the engagement and disengagement of ladders: maximum forces exerted by the men, two-handed operation.

The figures shown are the maximum force averaged over 12 measurements in each case (force), the standard deviation (SD), and the percentage deviation from the highest value measured in the direction of force concerned (%). A pulse peak value is also shown, since ladders are typically disengaged/engaged in practice by jerked movements. The fields highlighted in grey are the maximum values attained for this force scenario

Men																
$F_{\max} = 687 \text{ N}$																
$F_{\max\text{Peak}} = 1,226 \text{ N}$																
Women																
$F_{\max} = 373 \text{ N}$																
$F_{\max\text{Peak}} = 416 \text{ N}$																
Men		Pulling					Pushing					Lifting				
No	Height X [cm]	Force [N]	SD [N]	%	Peak [N]	SD [N]	Force [N]	SD [N]	%	Peak [N]	SD [N]	Force [N]	SD [N]	%		
1	215	246	32	36	819	32	311	20	49	578	33	479	44	96		
2	158	378	19	55	1,370	49	565	28	88	934	38	498	50	100		
3	120	468	16	68	1,266	40	638	25	100	845	49	404	58	81		
4	50	687	51	100	1,097	68	510	24	80	618	31	431	35	86		
5	15	595	69	87	781	53	432	32	68	456	20	408	46	82		
Women		Pulling					Pushing					Lifting				
No	Height X [cm]	Force [N]	SD [N]	%	Peak [N]	SD [N]	Force [N]	SD [N]	%	Peak [N]	SD [N]	Force [N]	SD [N]	%		
1	197	120	42	32	185	47	140	46	42	136	46	255	63	96		
2	145	178	52	48	357	77	241	56	72	278	61	266	68	100		
3	110	253	48	68	391	112	338	67	100	356	55	259	82	97		
4	46	372	34	100	416	98	245	51	73	249	26	177	79	66		
5	14	270	60	72	289	98	160	89	47	186	56	195	89	73		

Annex 6: Guideline values for maximum forces

Guideline values for the operation of levers or comparable manually operated parts

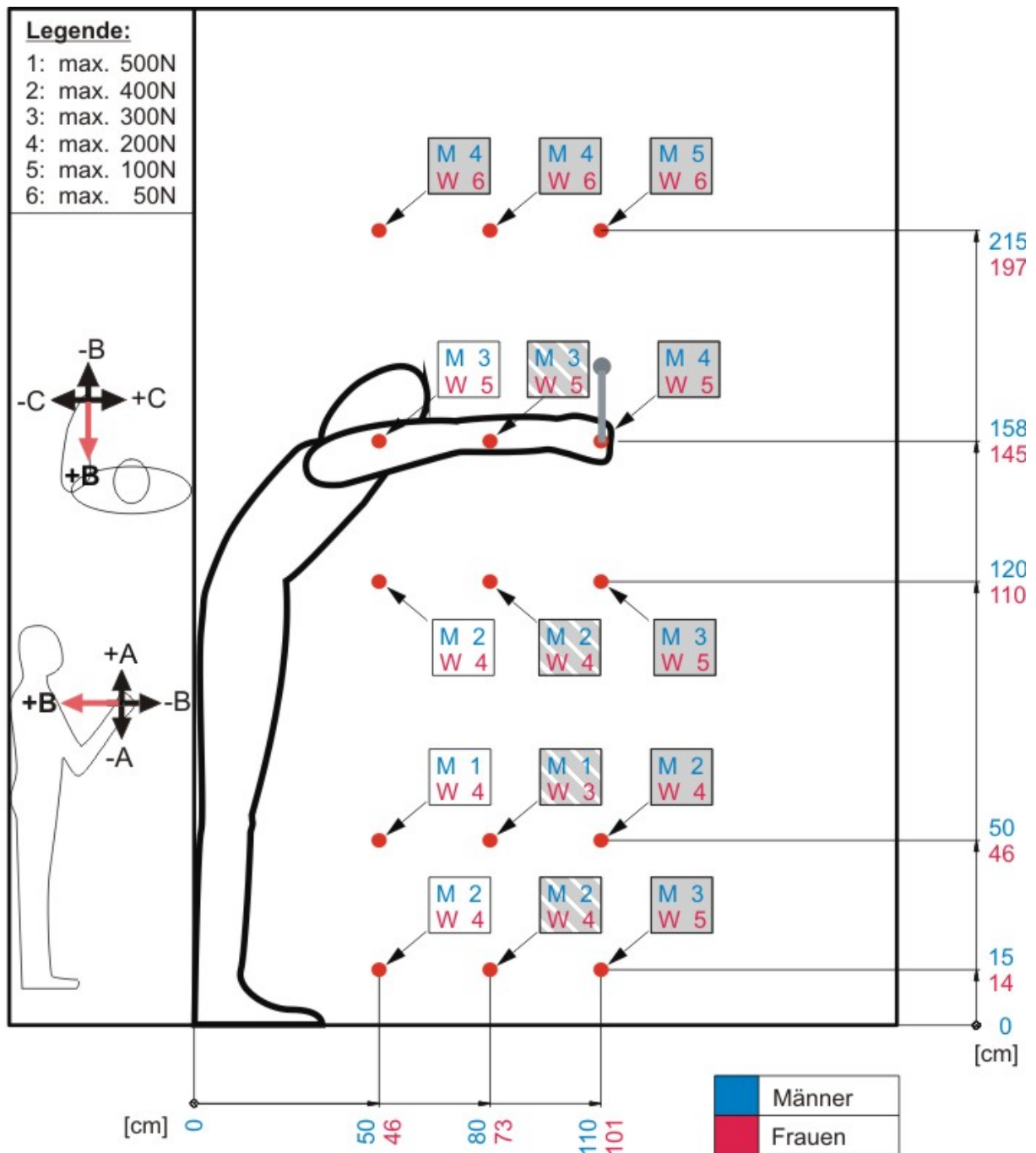

Fig. 160: Guideline maximum force values (exerted by men and women) for the following force scenario: Pulling the manually operated part towards the body (direction of force B+), one-handed operation in a range of postures (dimensions: distance from the heel to the manually operated part, in cm). Areas highlighted in grey are at or beyond the reach of many persons and are not recommended

Guideline values for the operation of levers or comparable manually operated parts

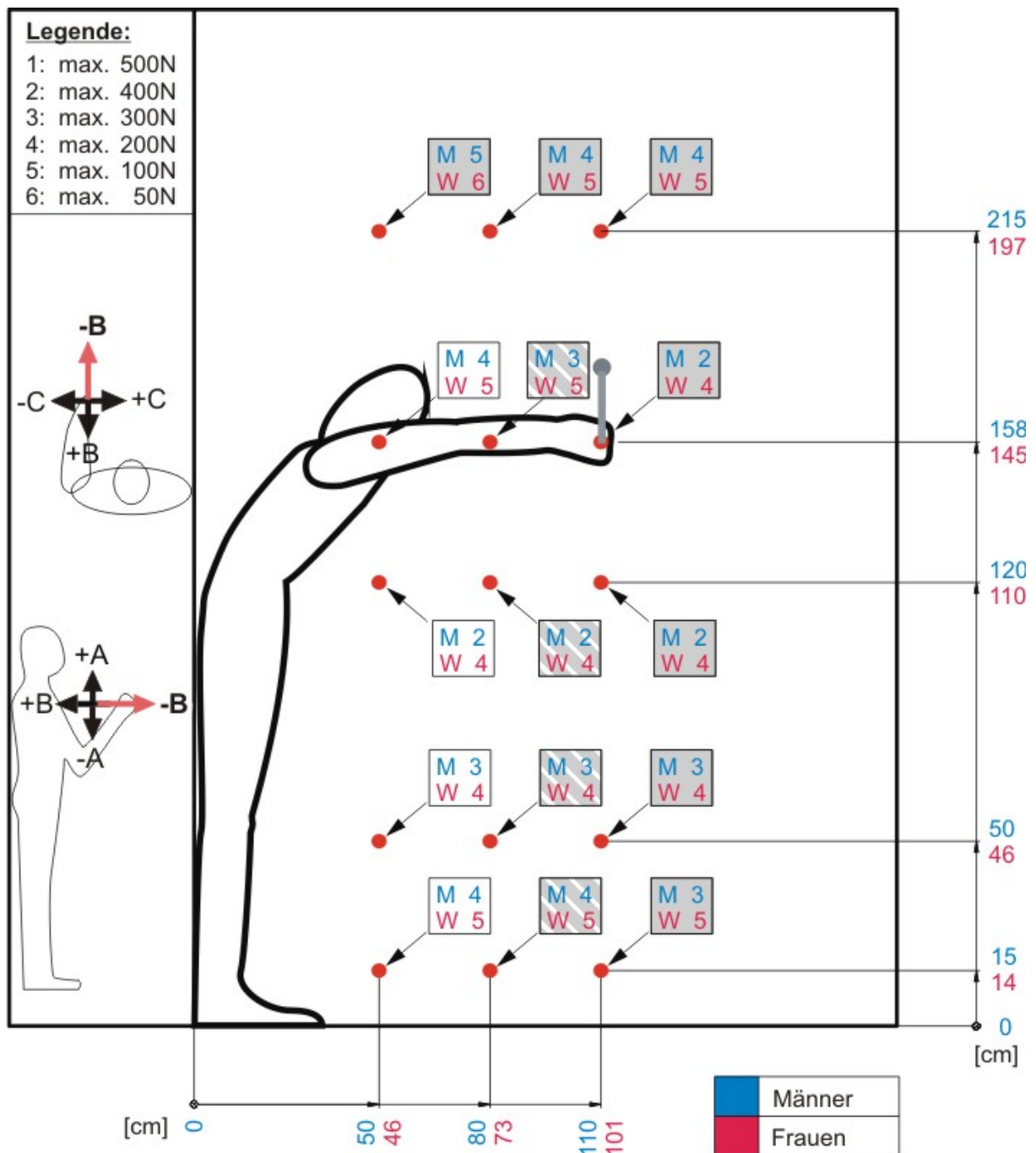

Fig. 161: Guideline maximum force values (exerted by men and women) for the following force scenario: Pushing the manually operated part away from the body (towards the machine, direction of force B-), one-handed operation in a range of postures (dimensions: distance from the heel to the manually operated part, in cm). Areas highlighted in grey are at or beyond the reach of many persons and are not recommended

Guideline values for the operation of levers or comparable manually operated parts

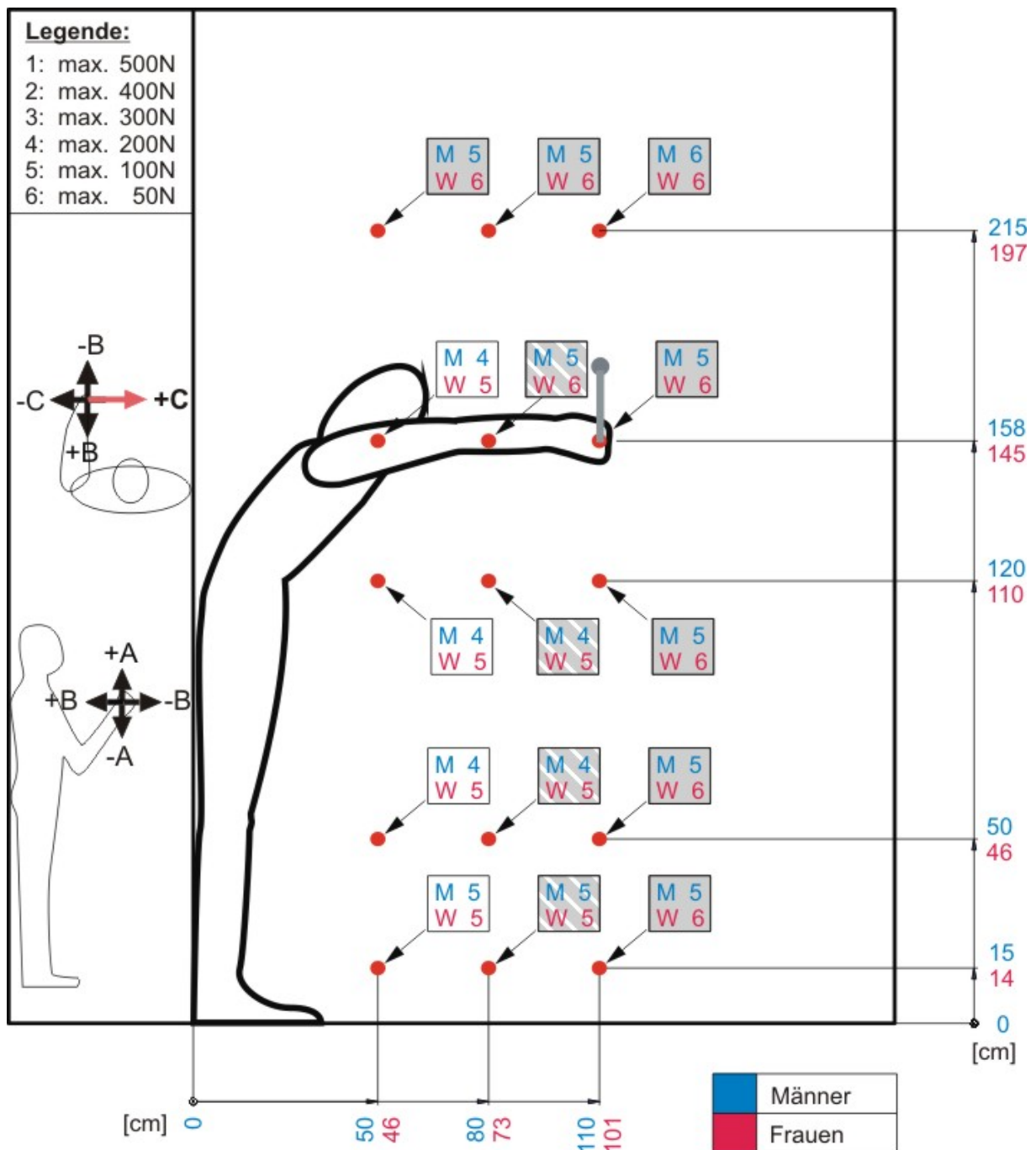

Fig. 162: Guideline maximum force values (exerted by men and women) for the following force scenario: Pulling/pushing the manually operated part sideways towards the back of the hand (direction of force C+), one-handed operation in a range of postures (dimensions: distance from the heel to the manually operated part, in cm). Areas highlighted in grey are at or beyond the reach of many persons and are not recommended

Guideline values for the operation of levers or comparable manually operated parts

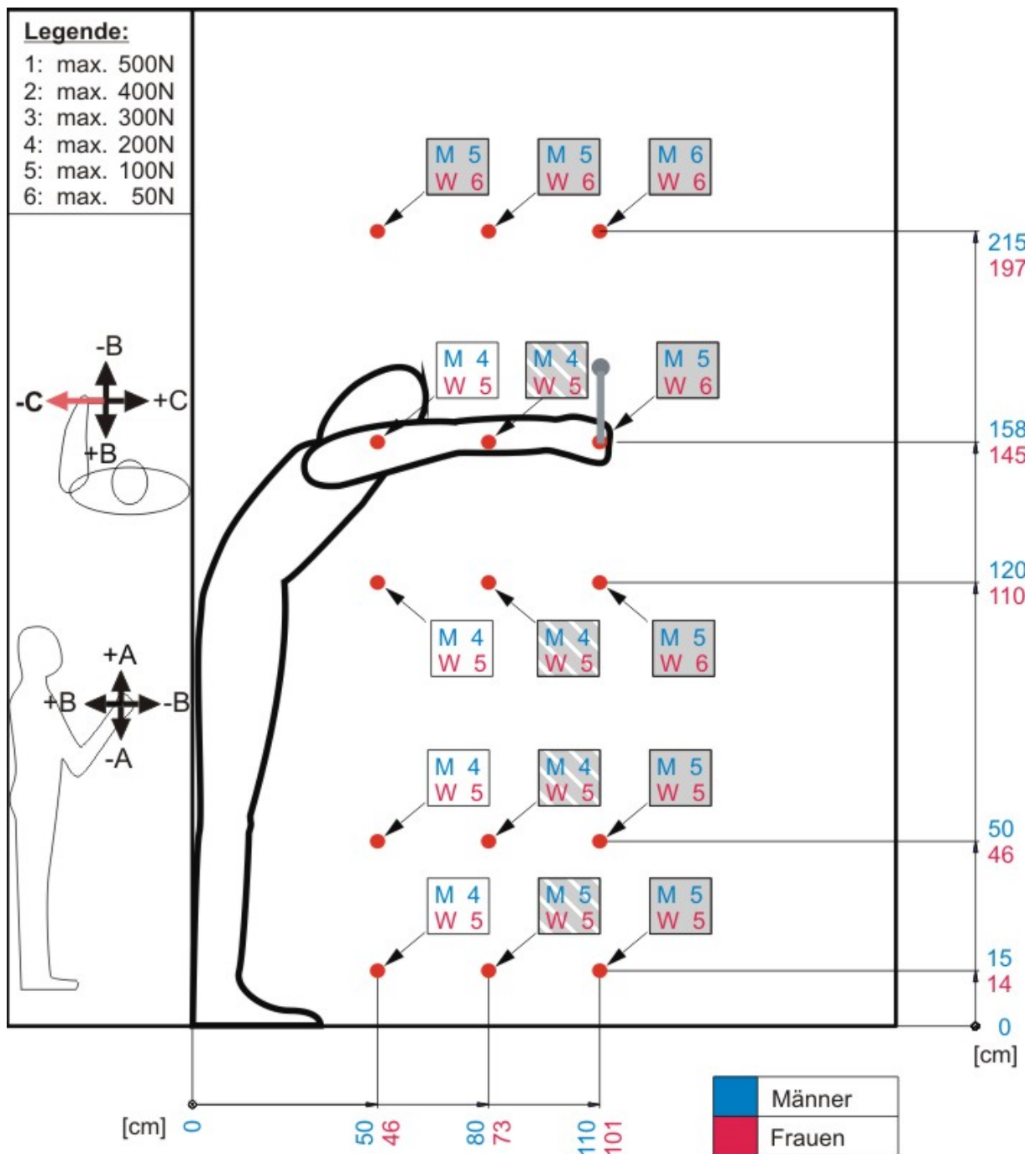

Fig. 163: Guideline maximum force values (exerted by men and women) for the following force scenario: Pulling/pushing the manually operated part sideways to the palm side of the hand (direction of force C-), one-handed operation in a range of postures (dimensions: distance from the heel to the manually operated part, in cm). Areas highlighted in grey are at or beyond the reach of many persons and are not recommended

Guideline values for the operation of levers or comparable manually operated parts

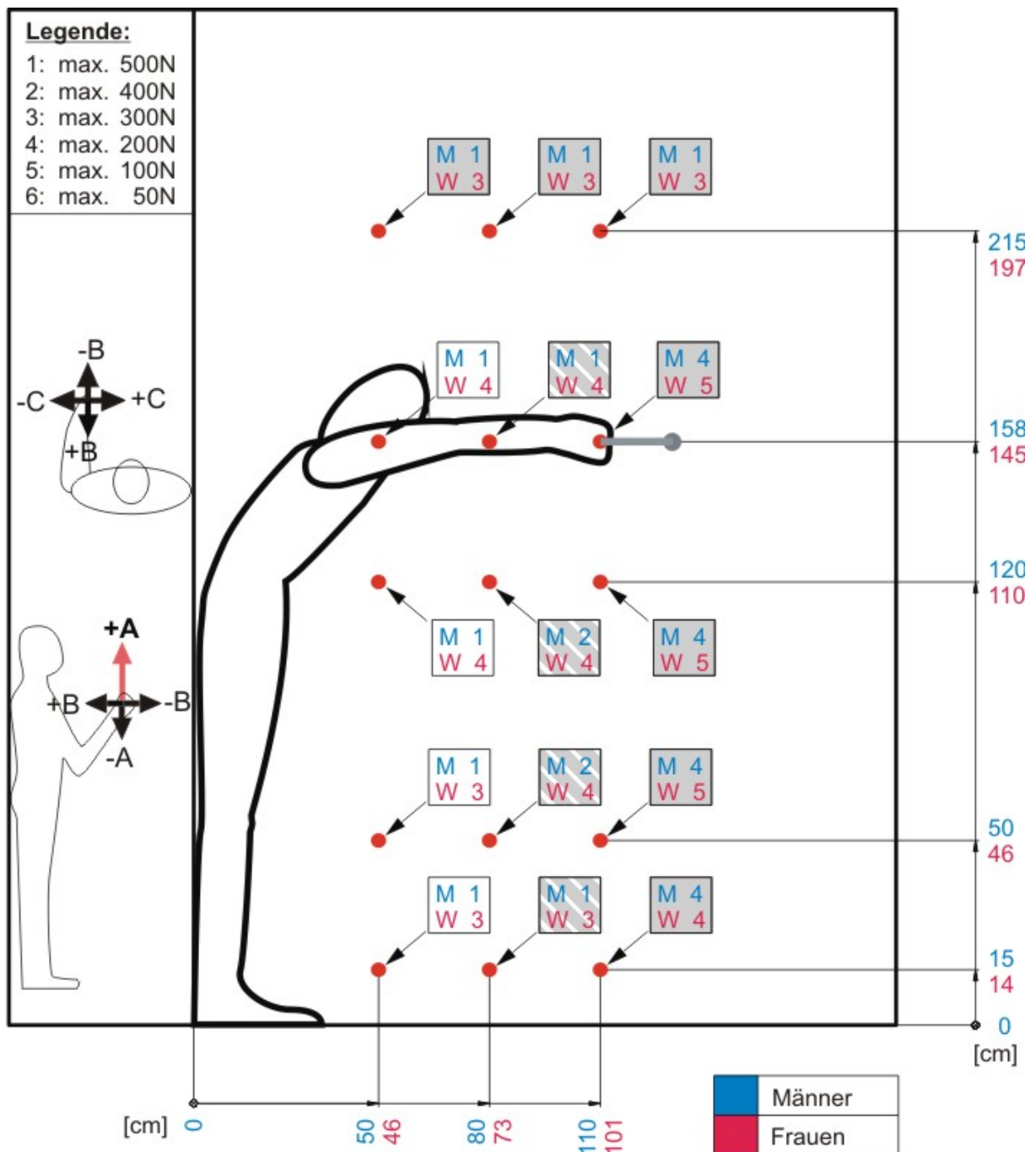

Fig. 164: Guideline maximum force values (exerted by men and women) for the following force scenario: Pushing/pulling the manually operated part upwards (direction of force A+), one-handed operation in a range of postures (dimensions: distance from the heel to the manually operated part, in cm). Areas highlighted in grey are at or beyond the reach of many persons and are not recommended

Guideline values for the operation of levers or comparable manually operated parts

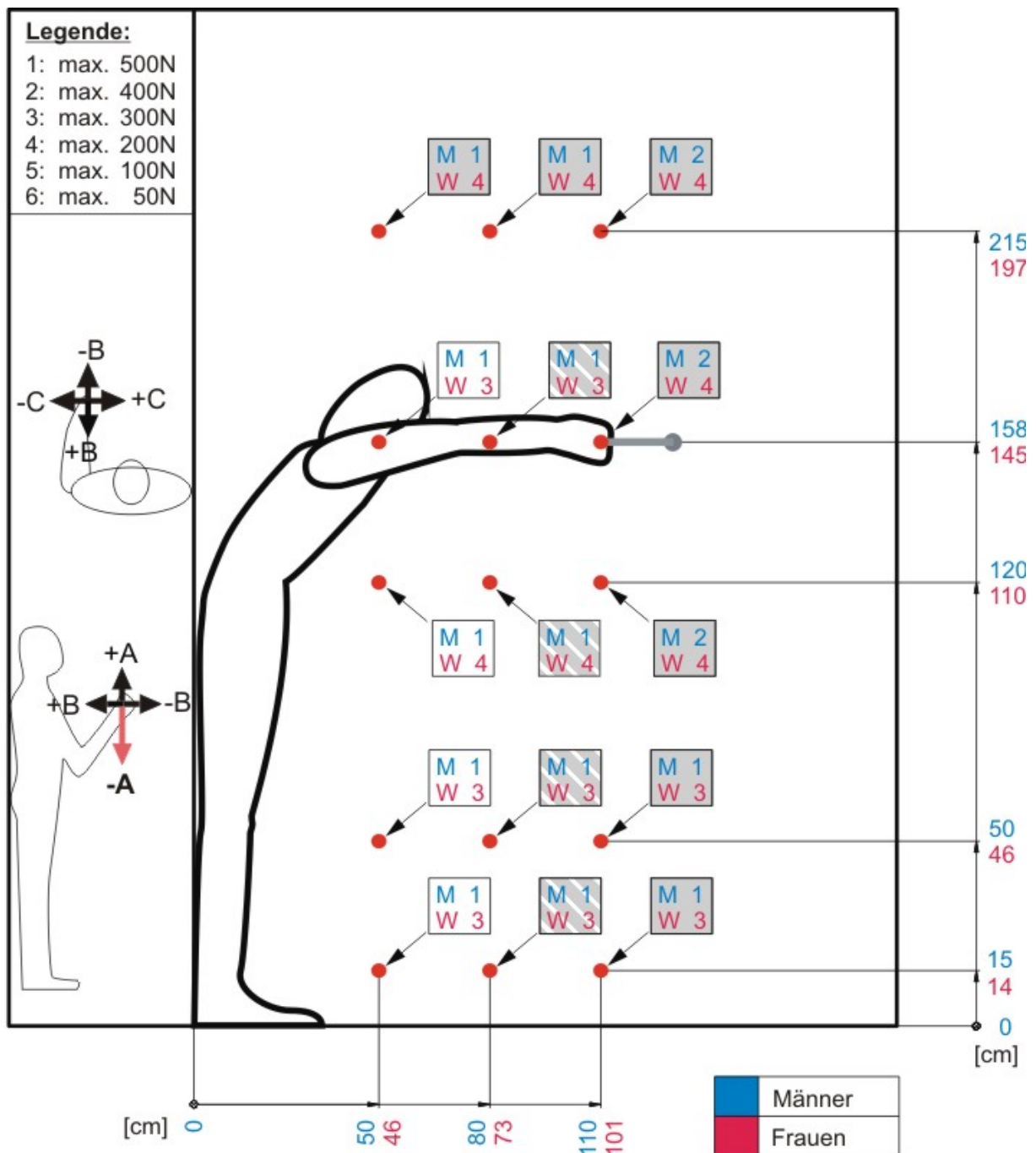

Fig. 165: Guideline maximum force values (exerted by men and women) for the following force scenario: Pushing/pulling the manually operated part downwards (direction of force A-), one-handed operation in a range of postures (dimensions: distance from the heel to the manually operated part, in cm). Areas highlighted in grey are at or beyond the reach of many persons and are not recommended

Guideline values for the moving of flaps, covers, shrouds and other components

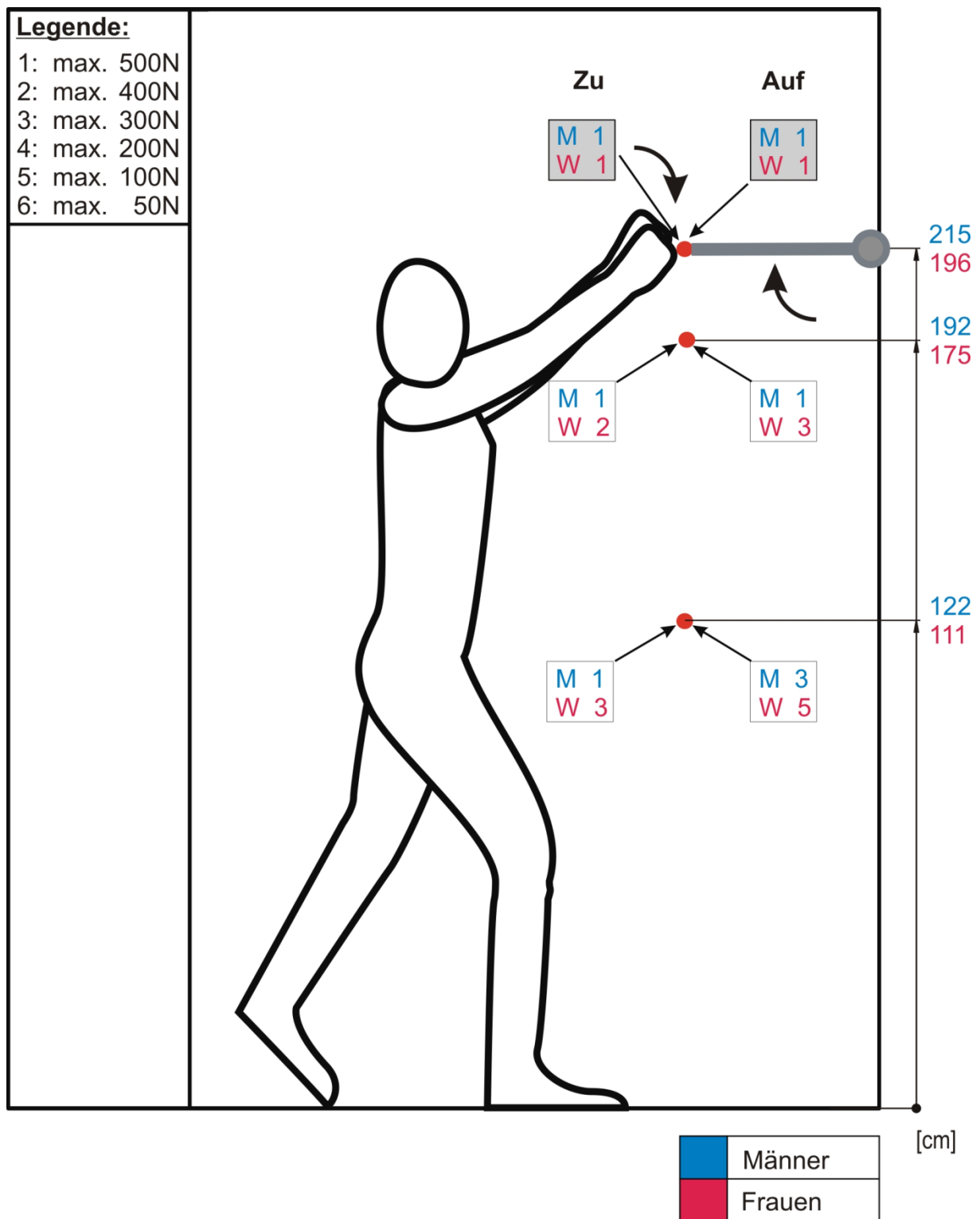

Fig. 166: Guideline maximum force values (exerted by men and women) for the following force scenario: Swivelling of manually operated parts, horizontal position, two-handed operation at a range of heights (dimensions: distance from the ground to the manually operated part, in cm). Areas highlighted in grey are at or beyond the reach of many persons and are not recommended

Guideline values for the moving of flaps, covers, shrouds and other components

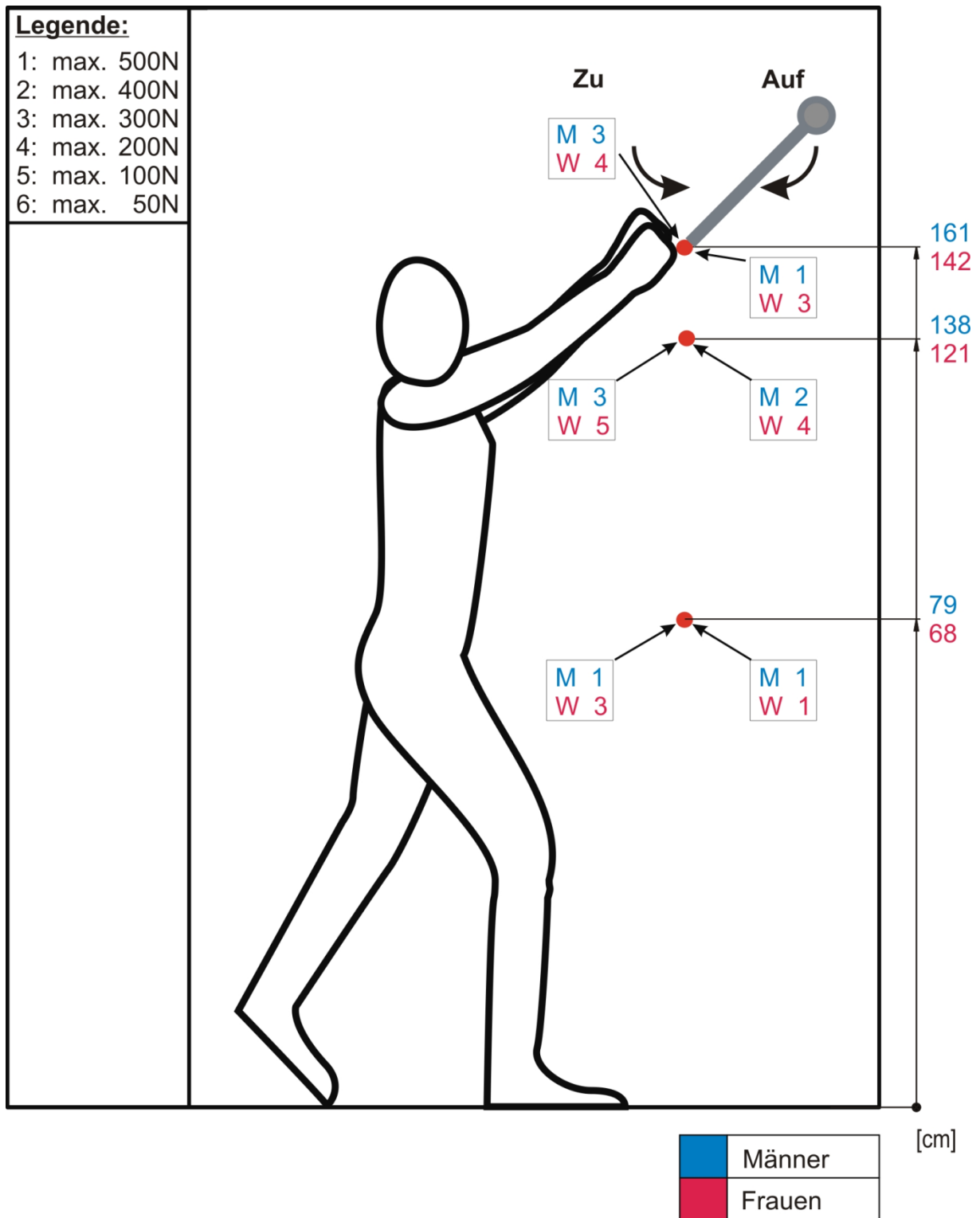

Fig. 167: Guideline maximum force values (exerted by men and women) for the following force scenario:
 Swivelling of parts, part at an angle of 45°, two-handed operation at a range of heights (dimensions: distance from the ground to the manually operated part, in cm)

Guideline values for the moving of flaps, covers, shrouds and other components

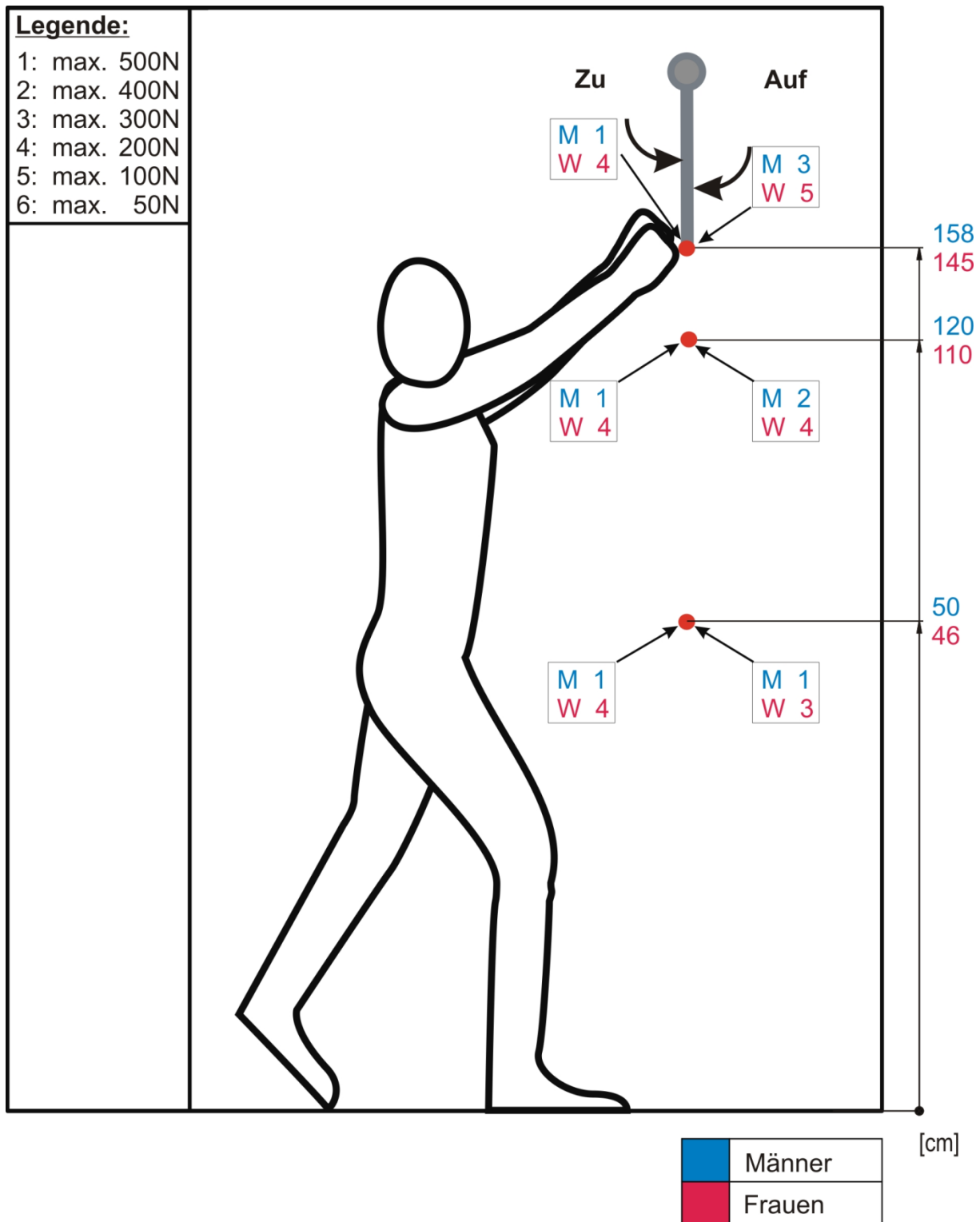

Fig. 168: Guideline maximum force values (exerted by men and women) for the following force scenario: Swivelling of parts, vertical position, two-handed operation at a range of heights (dimensions: distance from the ground to the manually operated part, in cm)

Guideline values for the moving of steps and ladders

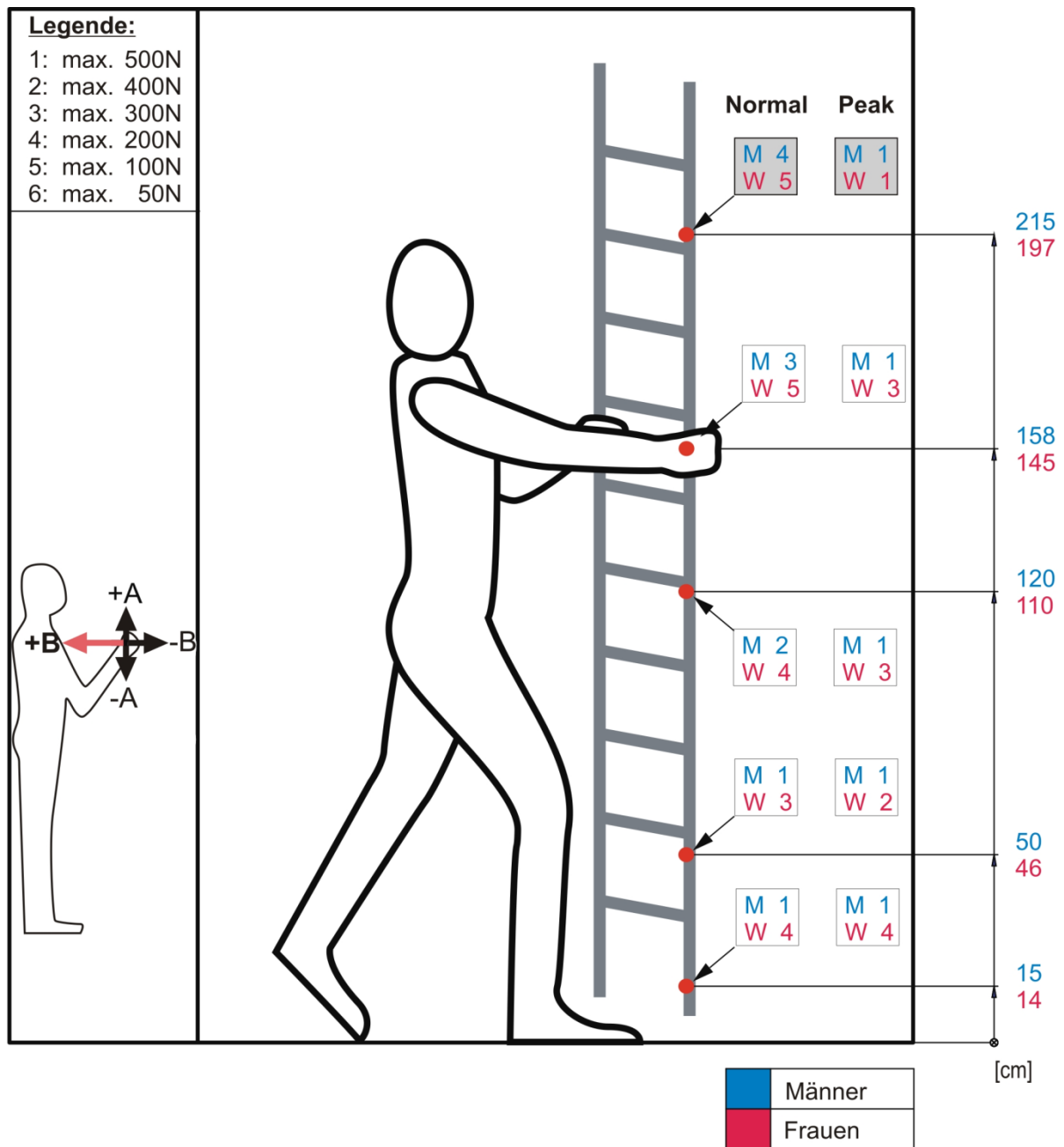

Fig. 169: Guideline maximum force values (exerted by men and women) for the following force scenario: Pulling of steps or a ladder towards the body (direction of force B+), two-handed operation at a range of heights (dimensions: distance from the ground to the manually operated part, in cm). Peak values are also stated in addition to the "normal" maximum values. These peak values can be used when the part must be jerked to be disengaged. The areas highlighted in grey are at or beyond many people's reach and are not recommended

Guideline values for the moving of steps and ladders

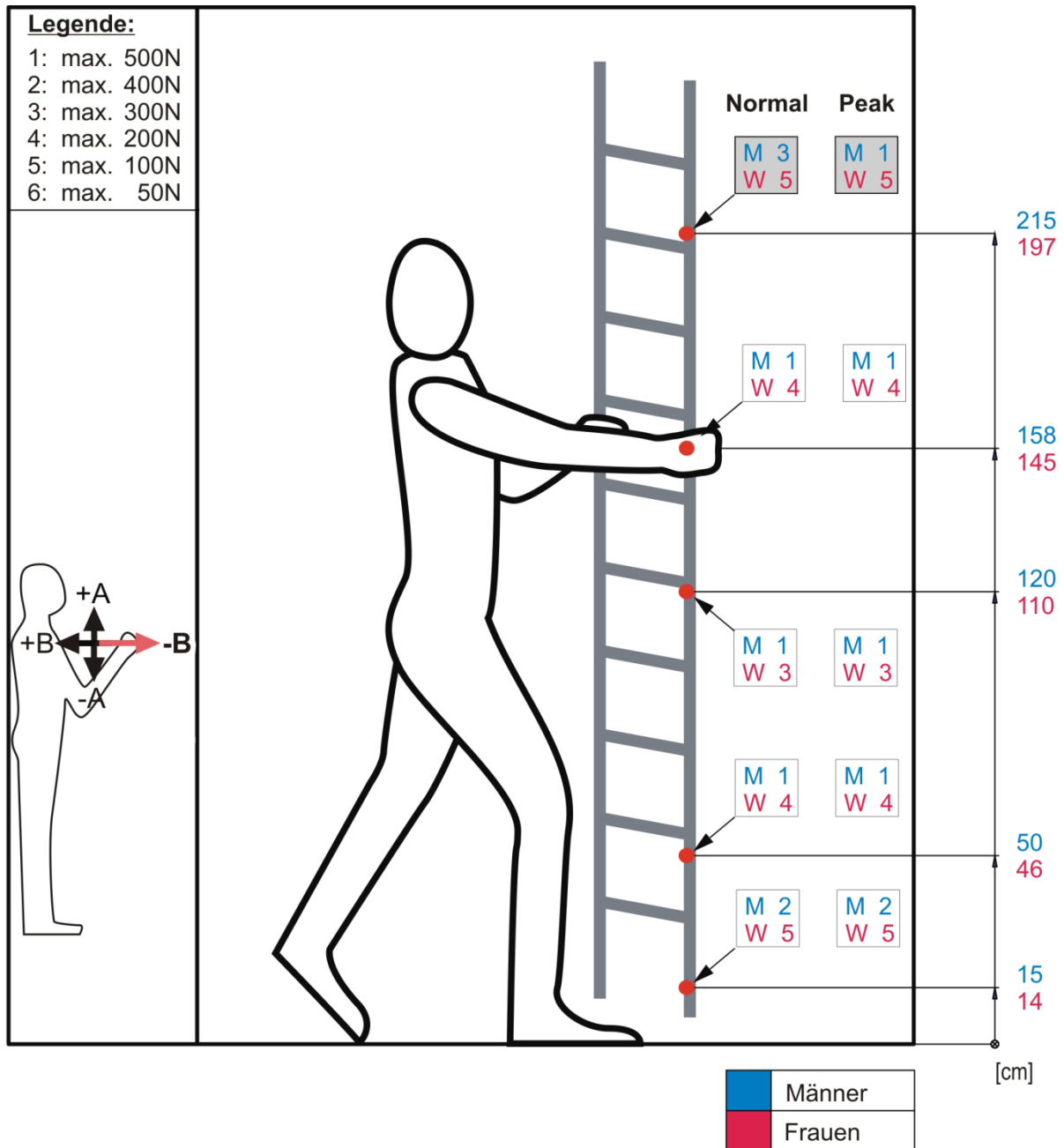

Fig. 170: Guideline maximum force values (exerted by men and women) for the following force scenario: Pushing of steps or a ladder away from the body (force of direction B-), two-handed operation at a range of heights (dimensions: distance from the ground to the manually operated part, in cm). Peak values are also stated here besides the "normal" maximum values. These peak values can be used when the part must be jerked to be engaged. The areas highlighted in grey are at or beyond many people's reach and are not recommended

Guideline values for the moving of steps and ladders

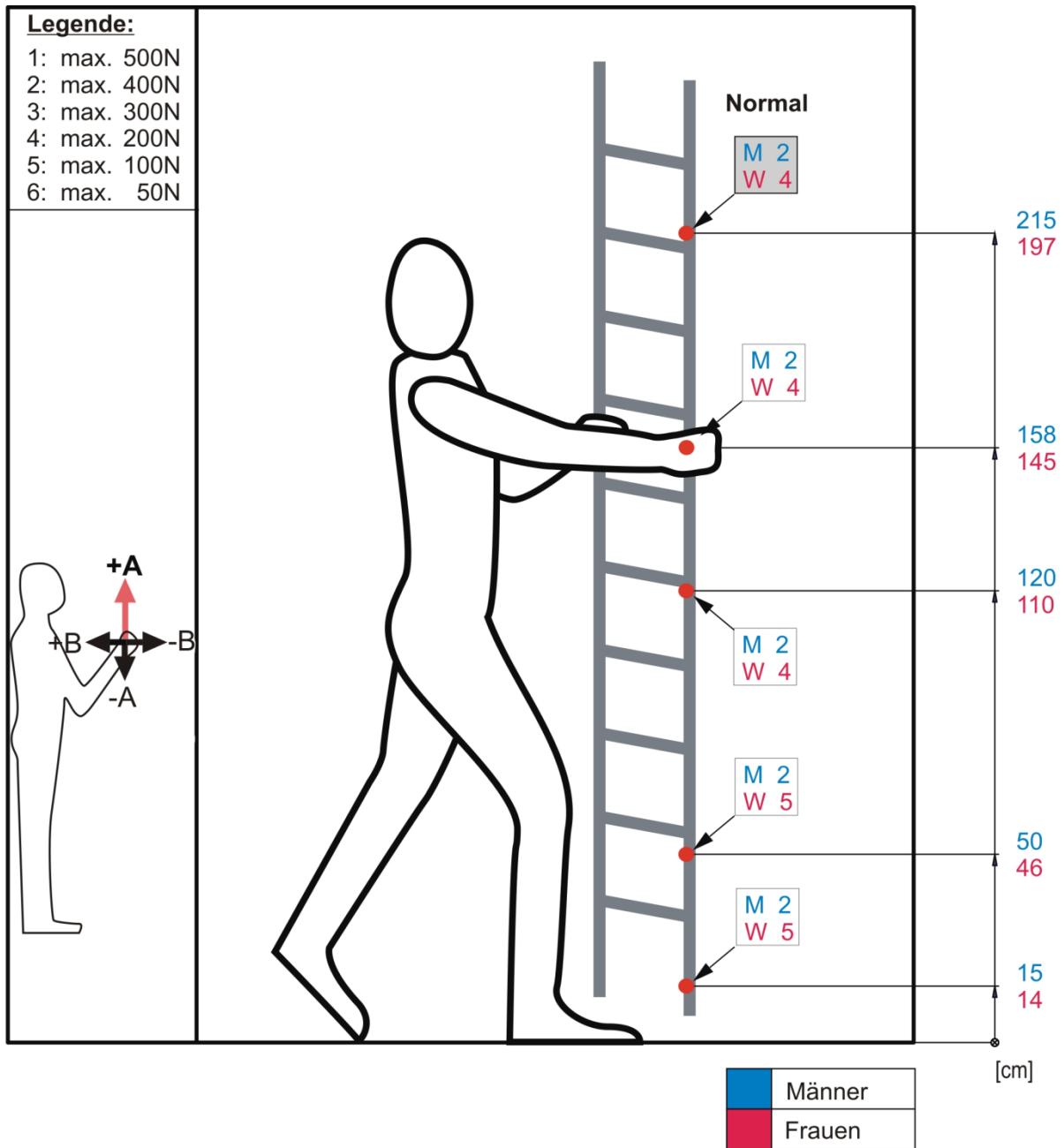

Fig. 171: Guideline maximum force values (exerted by men and women) for the following force scenario: Pushing of steps or a ladder upwards (direction of force A+), two-handed operation at a range of heights (dimensions: distance from the ground to the manually operated part, in cm). The area highlighted in grey is at or beyond many people's reach and is not recommended